

MADE IN ITALY. MADE TO EXCEL.

LIMS

Interactive version

STONE LOOK

COLOURED BODY PORCELAIN TILES GRES PORCELLANATO COLORATO IN MASSA

Grès cérame coloré dans la masse
Durchgefärbtes Feinsteinzeug
Gres porcelánico coloreado en masa
Керамический гранит окрашенный в массе

WHITE-BODY WALL TILES RIVESTIMENTI IN PASTA BIANCA

Revêtements en pâte blanche
Weißscherbige Wandfliesen
Revestimientos en pasta blanca
Настенная плитка из белой глины



Atlas Concorde is a global specialist in premium porcelain and wall tiles for every style and application in residential, commercial and public architecture. Being global specialists means excellence in the level of design and technology in each type of surface, making it possible to always offer designers and end users the best solution for each application.

Atlas Concorde è specialista globale in superfici ceramiche d'eccellenza per ogni stile e applicazione nell'architettura residenziale, commerciale e pubblica. Essere specialisti globali significa eccellere per livello di design e tecnologia in ciascun tipo di superficie, così da offrire sempre ai progettisti e agli utilizzatori finali la soluzione migliore per ogni applicazione.

atlasconcorde.com



INDEX



OVERVIEW



IMAGE GALLERY



PRODUCT RANGE & TECHNICAL SPECS.



SUSTAINABILITY



THE BENEFITS OF CERAMIC TILES



ENJOY THE VIDEO



Index



Overview

OVERVIEW >

Image Gallery

IMAGE GALLERY >

Product Range & Technical Specs

RANGE SUMMARY
TRIM TILES
TECHNICAL FEATURES

PRODUCT RANGE & TECHNICAL SPECS. >

Sustainability

SUSTAINABILITY >

The benefits of Ceramic Tiles

THE BENEFITS OF CERAMIC TILES >



PORCELAIN AND WALL TILES: A SAFE CHOICE

RECYCLABLE
Riciclabile

HYGIENIC
Igienico

ECO-FRIENDLY
Ama l'ambiente

RESISTANT
Resistente

FIREPROOF
Non brucia

LONG LASTING
Dura a lungo

VERSATILE
Versatile

SAFE
Sicuro

EASY TO CLEAN AND DISINFECT
Facile da pulire e sanificare

ZERO PVC
Zero PVC

INDEX



OVERVIEW



IMAGE GALLERY



PRODUCT RANGE & TECHNICAL SPECS.



SUSTAINABILITY



THE BENEFITS OF CERAMIC TILES



ENJOY THE VIDEO

UNIQUE SURFACES

The Lims collection features the authentic appeal of the most famous and sought-after Limestones, very diverse in their composition and origin. French Hauteville, Portuguese Moleanos, German Jura, Italian stone from Vicenza and Slovenian Lipika merge into surfaces with unique, unrepeatable graphics that convey the memory of times and places where the original stone was formed and sedimented.

La collezione Lims raccoglie ed elabora il fascino autentico delle pietre calcaree Limestone più note e ricercate, diverse per composizione e provenienza.

Le Hauteville francesi, le Moleanos portoghesi, le tedesche Jura, la pietra italiana di Vicenza e la Lipika slovena si fondono in superfici dalle grafiche uniche e irripetibili, che raccontano la memoria del tempo e dei luoghi in cui le pietre di ispirazione si sono formate e sedimentate.

La collection Lims rassemble et élabore le charme authentique des pierres calcaires les plus célèbres et les plus recherchées, différentes par leur composition et leur origine. La Hauteville française, les Moleanos portugaises, les Jura allemandes, la pierre italienne de Vicence et la Lipika slovène se fondent dans des surfaces au graphisme unique et inédit, qui racontent la mémoire du temps et des lieux où les pierres de l'inspiration se sont formées et ont sédimenté.

Die Kollektion Lims umschließt den authentischen Charme einiger der bekanntesten und beliebtesten, in Zusammensetzung und Herkunft unterschiedlichen Kalksteine (Limestones). Die französischen Hauteville, die portugiesischen Moleanos, die deutschen Jura, der italienische Vicenza-Stein und der slowenische Lipika verschmelzen zu Belägen mit einzigartigen und unwiederholbaren Grafiken, die vom Gedächtnis der Zeit erzählen und von den Orten, an denen sich die als Vorbild dienende Steine gebildet und abgelagert haben.

La colección Lims recoge y elabora el auténtico encanto de las piedras calizas Limestone más conocidas y refinadas, con diferentes composiciones y orígenes. Las Hauteville francesas, las piedras Moleanos portuguesas, las Jura alemanas, la piedra italiana de Vicenza y la Lipika eslovena se funden en superficies con gráficos únicos e irrepitibles, que cuentan la memoria del tiempo y los lugares donde se formaron y sedimentaron las piedras de inspiración.

Коллекция Lims собирает вместе и переосмысливает аутентичную красоту разных по составу и происхождению известняков. Фактуры французских пород Hauteville, португальских Moleanos, немецких Jura, итальянских Pietra di Vicenza и словенских Lipika сплавляются в неповторимый рисунок, который повествует о далеких временах и местах, где породы образовались.



Overview

INDEX



OVERVIEW



IMAGE GALLERY



PRODUCT RANGE & TECHNICAL SPECS.



SUSTAINABILITY



THE BENEFITS OF CERAMIC TILES



ENJOY THE VIDEO

RICH GRAPHIC TEXTURES

The graphic contrasts create a texture rich in accurate, realistic details. On the surfaces you can see fossils and shells, areas with parallel layers that testify to the progressive deposition of sediment over the centuries, others characterized by rocky aggregates or drawn only by the fine grain of the stone. A collection with a strong earthy personality yet at the same time simple and welcoming.

I contrasti grafici creano una texture ricca di dettagli particolarmente curati e realistici: sulle superfici si intravedono fossili e conchiglie, zone con stratificazioni parallele che testimoniano la deposizione progressiva di sedimenti avvenuta nel corso dei secoli, altre caratterizzate da aggregati rocciosi o disegnate soltanto dalla grana fine della pietra. Una collezione dalla forte personalità materica e al tempo stesso essenziale ed accogliente.

Les contrastes graphiques créent une texture riche en détails particulièrement précis et réalistes: sur les surfaces, on peut voir des fossiles et des coquillages, des zones avec des stratifications parallèles qui témoignent du dépôt progressif de sédiments au cours des siècles, d'autres caractérisées par des agrégats rocheux ou dessinées uniquement par le grain fin de la pierre. Une collection avec une forte personnalité matérielle et en même temps essentielle et accueillante.

Die grafischen Kontraste bilden eine an sorgfältig ausgeführten und realistischen Details reiche Textur: an den Oberflächen sind Fossilien und Muscheln erkennbar, sowie Zonen mit parallelen Schichtungen, die von der im Laufe der Jahrhunderte erfolgten progressiven Ablagerung von Sedimenten zeugen. Andere wiederum sind von felsigen Zusammenschlüssen geprägt, oder nur durch die feine Steinkörnung gezeichnet. Eine Kollektion von starker, stofflicher Persönlichkeit, die zugleich schlicht und einladend wirkt.

Los contrastes gráficos crean una textura rica en detalles, particularmente precisa y realista: se pueden ver fósiles y conchas en las superficies, zonas con estratificaciones paralelas que atestiguan el depósito progresivo de sedimentos a lo largo de los siglos, otras caracterizadas por agregados de roca o dibujadas sólo por el fino grano de la piedra. Una colección con una fuerte personalidad material, pero esencial y acogedora a la vez.

Контрасты рисунка образуют богатую деталями и необыкновенно реалистичную текстуру: на некоторых участках плиток видны окаменелости и раковины, полосы и наслоения, которые свидетельствуют о постепенных, происходивших на протяжении веков осадочных отложениях; на других можно наблюдать скопление обломков; на третьих заметен только мелкозернистый рисунок камня. У коллекции сильный характер, она строга, но вместе с тем способна вдохнуть в интерьер теплый уют.

INDEX



OVERVIEW



IMAGE GALLERY



PRODUCT RANGE & TECHNICAL SPECS.



SUSTAINABILITY



THE BENEFITS OF CERAMIC TILES



ELEGANT, NATURAL SHADES

The rich, textured effect of Lims surfaces is softened by the warm, natural and refined shades of the color palette. A collection perfectly in line with current interior design trends, ideal for the decoration of welcoming yet elegant and modern environments.

L'effetto ricco e materico delle superfici Lims si attenua nelle tonalità calde, naturali e raffinate della palette colori. Una collezione perfettamente in linea con le attuali tendenze dell'interior design, ideale per la progettazione di ambienti accoglienti e al tempo stesso eleganti e moderni.

L'effet riche et texturé des surfaces Lims est atténué par les nuances chaudes, naturelles et raffinées de la palette de couleurs. Une collection qui s'inscrit parfaitement dans les tendances actuelles de la décoration intérieure, idéale pour la conception d'environnements accueillants et en même temps élégants et modernes.

Die intensive, stoffliche Wirkung der Oberflächen von Lims wird durch die warmen, natürlichen und eleganten Nuancen der Farbpalette gedämpft. Eine perfekt auf die aktuellen Trends des Innendesigns abgestimmte Kollektion, ideal zur Planung von Räumen, die behaglich und gleichzeitig elegant und modern wirken.

El efecto rico y material de las superficies Lims se atenúa en las cálidas, naturales y refinadas tonalidades de la paleta de colores. Una colección que se ajusta perfectamente a las tendencias actuales de diseño de interiores, ideal para el diseño de ambientes acogedores pero elegantes y modernos.

Суровый фактурный эффект плиток Lims смягчается теплыми и натуральными оттенками цветовой палитры. Коллекция отражает последние тенденции дизайна интерьера и способна создать уютную, элегантную и в то же время стильную современную обстановку.

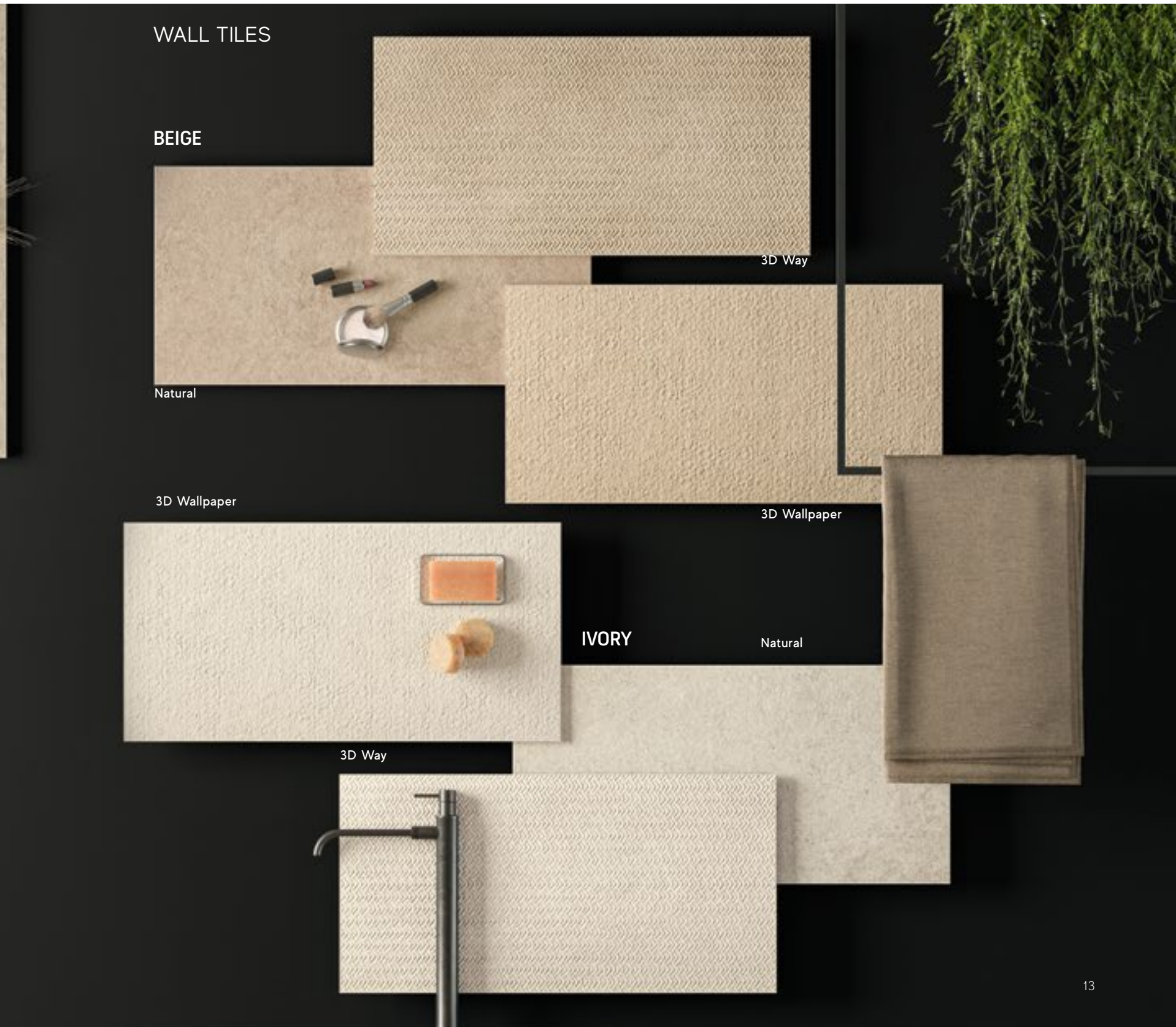
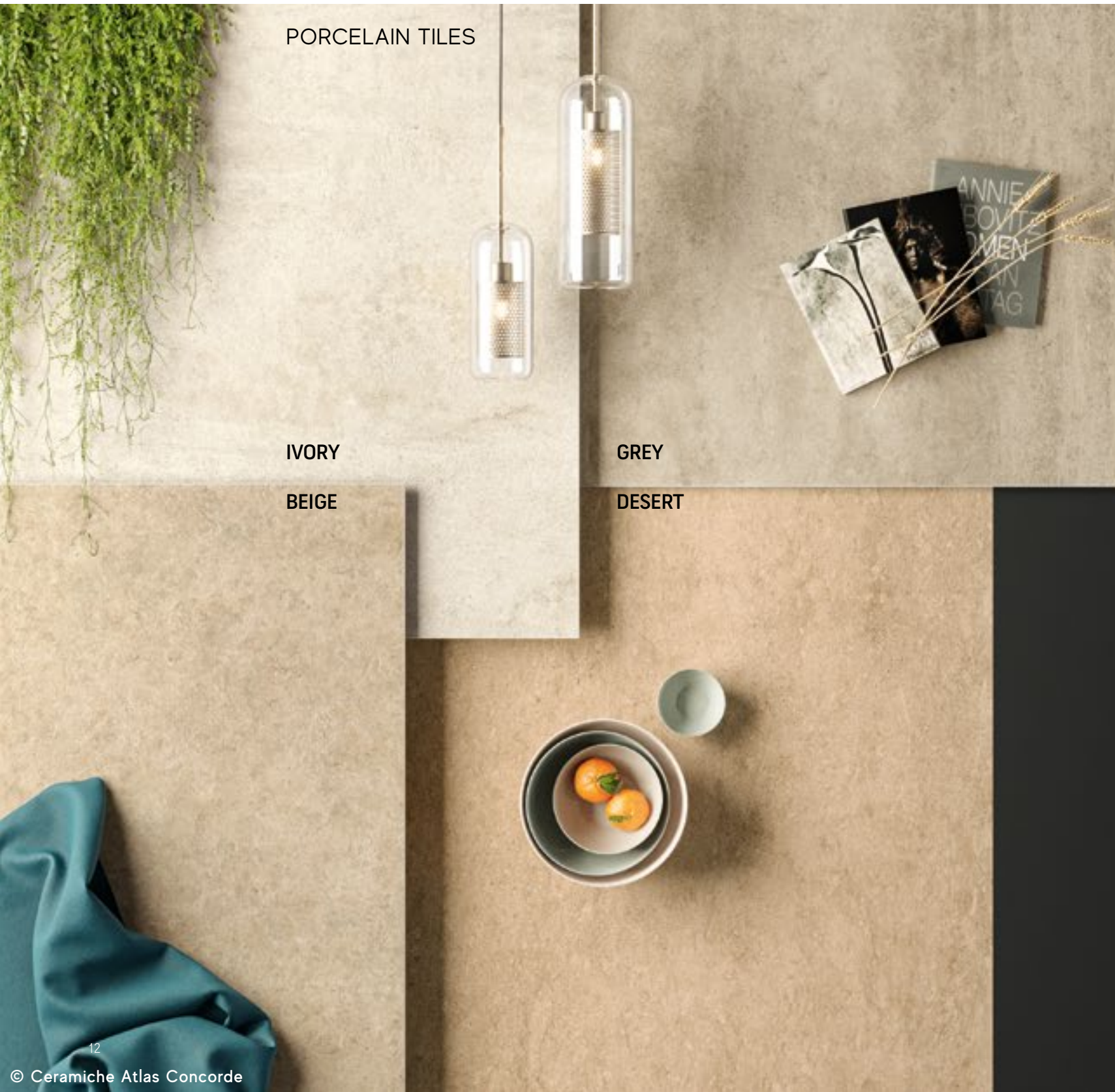

INDEX



OVERVIEW



IMAGE GALLERY



PRODUCT RANGE & TECHNICAL SPECS.



SUSTAINABILITY



THE BENEFITS OF CERAMIC TILES



ENJOY THE VIDEO

MULTIPLE FINISHES

The collection has three alternative surfaces in the size 37,5x75 cm (14 3/4" x 29 1/2"):

- **Natural**, with a slight three-dimensional microstructure effect that recalls the typical composition of Limestone.
- **Bush-hammered**, with a corrugated structure typical of machined natural stone, covered with shadows and patterns, for wall and floor use.
- **Line**: a striped texture and a three-dimensional microstructure with a matte finish, ideal for use on decorative walls.

The 37,5x75 cm (14 3/4" x 29 1/2") format is also available with a **tumbled edge** finish which gives the stone its characteristic antique look.

La collezione si caratterizza per la presenza di tre superfici alternative nel formato 37,5x75 cm:

- **Naturale**, con un leggero effetto di microstruttura tridimensionale che rimanda alla composizione tipica delle pietre Limestone;
- **Bocciardata**, con una struttura corrugata tipica delle lavorazioni delle pietre naturali, percorsa da ombre e chiaro-scuro, per un uso a parete e a pavimento;
- **Line**, con una texture rigata e una microstruttura tridimensionale, in finitura matt, ideale per un uso decorativo a parete.

Il formato 37,5x75 cm è disponibile anche nella finitura con bordi burattati (**Tumbled**) che conferiscono alla pietra il caratteristico aspetto anticato.

La collection est caractérisée par la présence de trois surfaces alternatives au format 37,5x75 cm :

- **Naturelle**, avec un léger effet de microstructure tridimensionnelle qui rappelle la composition typique des pierres calcaires ;
- **Bouchardée**, avec une structure ondulée typique du traitement des pierres naturelles, traversée par des ombres et des clair-obscur, pour un usage mural et au sol ;
- **Line**, avec une texture rayée et une microstructure tridimensionnelle, en finition mate, idéale pour une utilisation murale décorative.

Le format 37,5x75 cm est également disponible dans la finition à bord tamisé (**Tumbled**) qui donne à la pierre son aspect vieilli caractéristique.

Die Kollektion umfasst drei alternative Oberflächen im Format 37,5x75 cm:

- **Natur**, mit einem leichten, dreidimensionalen Mikrostruktureffekt, der auf die typische Zusammensetzung des Kalksteins verweist;
- **Gekrönel**, mit einer gewellten Struktur, wie sie für die Bearbeitungen von Naturstein typisch ist, geprägt von Schatten und Hell/Dunkel-Effekten, für den Einsatz an Wand und Boden;
- **Line**: mit einer gerillten Textur und einer dreidimensionalen Mikrostruktur, in der Oberflächenversion matt.

Ideal für eine dekorative Verwendung an der Wand. Das Format 37,5x75 cm ist auch mit getrommelten Kanten (**Tumbled**) lieferbar, die dem Stein ein charakteristisches, antikisiertes Aussehen verleihen.

La colección se caracteriza por la presencia de tres superficies alternativas en formato 37,5x75 cm:

- **Natural**, con un ligero efecto de microestructura tridimensional que recuerda la composición típica de la piedra caliza;
- **Abujardada**, con una estructura corrugada típica de la elaboración de las piedras naturales, atravesadas por sombras y claroscuros, para uso en paredes y pavimentos;
- **Line**, con una textura rayada y una microestructura tridimensional, siempre en acabado mate, ideal para uso decorativo en paredes.

El formato 37,5x75 cm también está disponible en el acabado de bordes cribados (**Tumbled**) que otorgan a la piedra su característico aspecto antiguo.

Для формата 37,5x75 см доступны три альтернативные поверхности:

- **Натуральная**, с легкой рельефной микроструктурой, характерной для природного известняка;
- **Бучардированная**, с шероховатой, как у обработанного камня, структурой, на которой оригинально сплетаются свет и тень – для стен и полов;
- **Line**, с рифленной трехмерной микроструктурой для декорирования стен.

Формат 37,5x75 см доступен также в варианте с выщербленными кромками, придающими плиткам характерный состаренный вид.



NATURAL



BUSH-HAMMERED



TUMBLED



LINE

INDEX



OVERVIEW



IMAGE GALLERY



PRODUCT RANGE & TECHNICAL SPECS.



SUSTAINABILITY



THE BENEFITS OF CERAMIC TILES



ENJOY THE VIDEO

DIFFERENT SIZES FOR ANY SPACE

The wide range of formats, including the large 120x278 cm (47 1/4" x 109 1/2") size and an extensive array of decorations, makes the collection particularly versatile, able to respond to different design needs. By reducing the presence of joints, the large format creates a perception of visual continuity and esthetic harmony.

L'ampia gamma di formati, arricchita dalla presenza del grande formato 120x278 cm e da un articolato apparato decorativo, rende la collezione particolarmente versatile, in grado di rispondere alle diverse esigenze progettuali. Il grande formato, riducendo la presenza di fughe, crea una percezione di grande continuità visiva ed armonia estetica.

Le grand éventail de formats, enrichi par la présence du grand format 120x278 cm et par une gamme décorative articulée, rend la collection particulièrement versatile, capable de répondre à différentes exigences de design. Le grand format, en réduisant la présence de joints, crée une perception de grande continuité visuelle et d'harmonie esthétique.

Das große Formatangebot, das auch das Großformat 120x278 cm umfasst, und ein reiches Dekorsortiment machen die Kollektion ausgesprochen vielseitig und für die unterschiedlichsten Projekterfordernisse geeignet. Durch Reduzierung der Fugen erzeugt das Großformat eine große visuelle Kontinuität und harmonische Optik.

La amplia gama de formatos, enriquecida por la presencia del formato grande 120x278 cm y un aparato decorativo articulado, hace que la colección sea particularmente versátil, capaz de responder a diferentes necesidades de diseño. El formato grande, reduciendo la presencia de las juntas, crea una percepción de gran continuidad visual y armonía estética.

Гамма форматов охватывает также большие плиты 120x278 см и аккуратно подобранный набор декоров, который значительно увеличивает дизайнерский потенциал коллекции и позволяет вписать ее в самые разные по стилю проекты. Большой формат, сводя к минимуму количество швов, создает гармоничный эффект цельной, без разрывов поверхности.

PORCELAIN TILES FOR FLOOR AND WALL

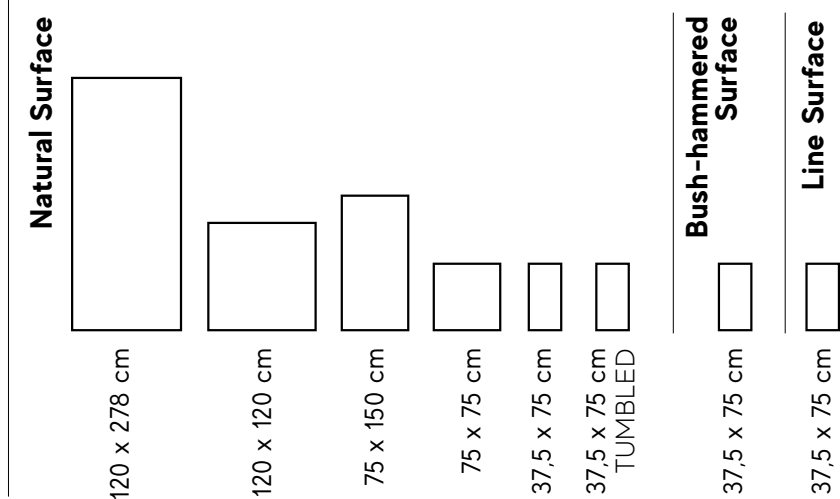

TILES FOR WALL COVERINGS

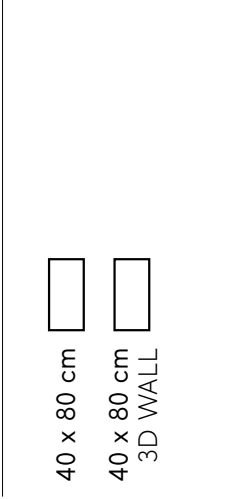

PORCELAIN TILES FOR OUTDOOR AND WET AREAS

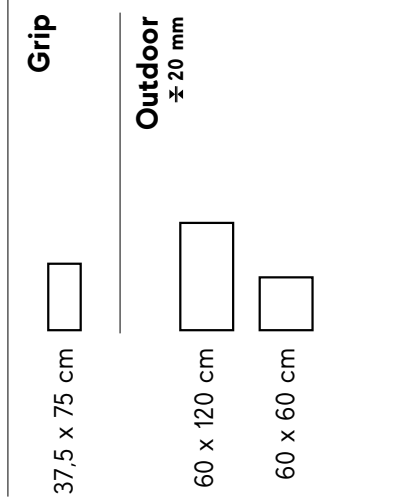

INDEX



OVERVIEW



IMAGE GALLERY



PRODUCT RANGE & TECHNICAL SPECS.



SUSTAINABILITY



THE BENEFITS OF CERAMIC TILES





INDOOR/OUTDOOR IN PERFECT HARMONY

The Lims collection is completed by outdoor tiles in sizes 60x60 cm (23 5/8" x 23 5/8") and 60x120 cm (23 5/8" x 47 1/4") with a thickness of 20 mm, and a grip version measuring 37,5x75 cm (14 3/4" x 29 1/2") and 9 mm thick. A highly sought-after solution in today's contemporary design that guarantees perfect stylistic continuity between indoor and outdoor spaces.

Completano la collezione Lims le proposte Outdoor, nei due formati 60x60 cm e 60x120 cm con spessore 20 mm e nella versione grip in formato 37,5x75 cm con spessore 9 mm. Una soluzione molto ricercata nella progettazione contemporanea attuale che garantisce una perfetta continuità stilistica tra ambienti interni ed esterni.

La collection Lims est complétée par les propositions Outdoor, dans les deux formats 60x60 cm et 60x120 cm avec une épaisseur de 20 mm et dans la version anti-glissement dans le format 37,5x75 cm avec une épaisseur de 9 mm. Une solution très recherchée dans le design contemporain actuel qui garantit une parfaite continuité de style entre intérieur et extérieur.



© Ceramiche Atlas Concorde

Komplettiert wird die Kollektion Lims durch die Outdoor-Produkte in den zwei Formaten 60x60 cm und 60x120 cm mit Stärke 20 mm sowie in der Version Grip im Format 37,5x75 cm mit Stärke 9 mm. Eine sehr beliebte Lösung in zeitgenössischen Projekten, die eine perfekte stilistische Kontinuität zwischen Innen- und Außenbereichen garantiert.

La colección Lims se completa con las propuestas para exteriores, en los formatos 60x60 cm y 60x120 cm con 20 mm de espesor y en la versión grip en tamaño 37,5x75cm con 9 mm de espesor. Una solución muy buscada en el diseño contemporáneo actual que garantiza una perfecta continuidad estilística entre los ambientes interiores y exteriores.

Коллекция Lims включает также уличную плитку форматов 60x60 см и 60x120 см толщиной 20 мм и формата 37,5x75 см толщиной 9 мм с противоскользящей поверхностью Grip. Такое решение позволяет добиться стилистического единства внутренних и наружных пространств, что особенно ценится в современном дизайне.

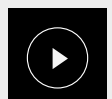

THREE-DIMENSIONAL PATTERNS



© Ceramiche Atlas Concorde

The selection of Lims decorations features two three-dimensional reliefs that reinterpret the classicism of the material, adding strength and expressive potential to the wall tiles:

- **3D Wallpaper:** 40x80 cm (15 3/4" x 31 1/2"), with delicate decorative textures that seem to emerge from a slightly tumbled stone surface.
- **3D Way** 40x80 cm (15 3/4" x 31 1/2"), inspired by artisanal engravings with a herringbone pattern.

L'apparato decorativo di Lims si arricchisce di due rilievi tridimensionali che rielaborano la classicità della materia aggiungendo forza e potenzialità espressiva ai rivestimenti a parete:

- 3D Wallpaper 40x80 cm, con delicate trame decorative che sembrano affiorare da una superficie in pietra leggermente burattata;
- 3D Way 40x80 cm, ispirato alle lavorazioni artigianali di incisione, con un pattern a spina di pesce.

La gamme décorative de Lims est enrichie de deux reliefs tridimensionnels qui retravaillent le classicisme de la matière en ajoutant de la résistance et un potentiel expressif aux revêtements muraux :

- 3D Wallpaper 40x80 cm, avec des textures décoratives délicates qui semblent émerger d'une surface de pierre légèrement effondrée ;
- 3D Way 40x80 cm, inspirée de la gravure artisanale, avec un motif en chevrons.

Das Dekorangebot von Lims bereichert sich um zwei dreidimensionale Muster, die den klassischen Charakter der Materie interpretieren und Wandbeläge um Kraft und Ausdruckspotenzial bereichern:

- 3D Wallpaper 40x80 cm, mit feinen, dekorativen Strukturen, die aus einer leicht getrommelten Steinfläche wie aufzublühen scheinen;
- 3D Way 40x80 cm, mit seinem Fischgrätmotiv ist an handwerklichen Gravurarbeiten inspiriert.

El aparato decorativo de Lims se enriquece con dos relieves tridimensionales que reelaboran el classicismo del material añadiendo fuerza y potencial expresivo a los revestimientos para paredes:

- 3D Wallpaper 40x80 cm, con delicadas tramas decorativas parecen emerger de una superficie de piedra ligeramente cribada;
- 3D Way 40x80 cm, inspirado en las elaboraciones artesanales de entalladura, con un patrón en espiga.

Гамма декоров Lims охватывает два трехмерных варианта плитки, придающих стенам особую выразительность:

- 3D Wallpaper 40x80 см, чей рельеф мягко всплывает на слегка выщербленной «каменной» поверхности;
- 3D Way 40x80 см, чей елочный узор кажется выгравированным вручную.



INDEX



OVERVIEW



IMAGE GALLERY



PRODUCT RANGE & TECHNICAL SPECS.



SUSTAINABILITY



THE BENEFITS OF CERAMIC TILES



ENJOY THE VIDEO



GREAT DESIGN FREEDOM

The decorations of the Lims collection come in a wide variety of shapes, figures and inspirations, greatly expanding the number of possible applications and compositions. They run from the brick-effect decoration to a reinterpretation of the typical hexagonal mosaic. An array of geometries crosses the entire decorative collection offering the designer great expressive freedom.

Una grande varietà di forme, figure e ispirazioni caratterizza il set decorativo della collezione Lims, esaltandone le possibilità applicative e compositive. Dal decoro effetto brick alla reinterpretazione del tipico mosaico esagonale, la geometria attraversa l'intero apparato decorativo offrendo al progettista una grande libertà espressiva.

Une grande variété de formes, de figures et d'inspirations caractérisent l'ensemble décoratif de la collection Lims, ce qui renforce ses possibilités d'application et de composition. De la décoration à effet brique à la réinterprétation de la mosaïque hexagonale typique, la géométrie traverse toute la gamme décorative offrant au concepteur une grande liberté d'expression.



© Ceramiche Atlas Concorde

Eine große Vielfalt an Formen, Figuren und Inspirationen prägt die Dekore der Kollektion Lims und unterstreicht ihre reichen Anwendungs- und Gestaltungsmöglichkeiten. Vom Dekor Brick bis zur Neuinterpretation des typischen Sechseckmosaiks über die gesamte Dekorpalette verfügt der Planer über maximale Ausdrucksfreiheit.

Una amplia variedad de formas, figuras e inspiraciones caracterizan el set decorativo de la colección Lims, mejorando sus posibilidades de aplicación y composición. Desde la decoración con efecto ladrillo hasta la reinterpretación del típico mosaico hexagonal, la geometría atraviesa todo el aparato decorativo ofreciendo al diseñador una gran libertad de expresión.

Набор декоративных элементов коллекции Lims отличается большим разнообразием форм, фигур и рисунков, которые значительно увеличивают ее композиционный и оформительский потенциал. От декоров с кирпичной геометрией до шестигранной мозаики – разноликая геометрия элементов позволяет дизайнерам максимально полно раскрыть свои идеи.

INDEX



OVERVIEW



IMAGE GALLERY



PRODUCT RANGE & TECHNICAL SPECS.



SUSTAINABILITY



THE BENEFITS OF CERAMIC TILES

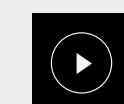

ENJOY THE VIDEO

Image Gallery

Contemporary Living
Beige Ivory



© Ceramiche Atlas Concorde

Swimming Pool Villa
Beige



© Ceramiche Atlas Concorde

Design Library Café
Grey



© Ceramiche Atlas Concorde

Charme Resort
Desert Ivory



© Ceramiche Atlas Concorde

Home Bathroom
Ivory



© Ceramiche Atlas Concorde

Hotel Restroom
Beige



© Ceramiche Atlas Concorde

INDEX



OVERVIEW



IMAGE GALLERY



CONTEMPORARY LIVING
Beige Ivory

SWIMMING POOL VILLA
Beige

DESIGN LIBRARY CAFÉ
Grey

CHARME RESORT
Desert Ivory

HOME BATHROOM
Ivory

HOTEL RESTROOM
Beige

PRODUCT
RANGE &
TECHNICAL
SPECS.



SUSTAINABILITY



THE BENEFITS OF
CERAMIC TILES



01 CONTEMPORARY LIMESTONE EFFECT



INDEX



OVERVIEW



IMAGE GALLERY



CONTEMPORARY LIVING
Beige Ivory

SWIMMING POOL VILLA
Beige

DESIGN LIBRARY CAFÉ
Grey

CHARME RESORT
Desert Ivory

HOME BATHROOM
Ivory

HOTEL RESTROOM
Beige

PRODUCT
RANGE &
TECHNICAL
SPECS.



SUSTAINABILITY



THE BENEFITS OF
CERAMIC TILES



ENJOY
THE VIDEO

With its extraordinary graphic richness, the Lims limestone effect furnishes every room with warmth and natural character. The realistic details of the textures and earthy effects of the finishes create surfaces that reproduce the look of worked stone.

Con la sua straordinaria ricchezza grafica, l'effetto pietra limestone di Lims arreda ogni ambiente rivestendolo di calore e naturalezza. I dettagli curati e realistici delle texture e gli effetti materici delle finiture creano superfici che riproducono le tecniche di lavorazione della pietra.

Grâce à son extraordinaire richesse graphique, l'effet pierre limestone de Lims décore et habille chaque espace de chaleur et de naturel. Les détails soignés et réalistes des textures, ainsi que l'effet des finitions, créent des surfaces qui reproduisent les techniques de façonnage de la pierre.

Con su extraordinaria riqueza gráfica, el efecto piedra limestone de Lims decora cada ambiente con calidez y naturalidad. Los detalles precisos y realistas de las texturas y los efectos materiales de los acabados crean superficies que reproducen las técnicas de elaboración de la piedra.

Mit seinem außerordentlichen grafischen Reichtum gestaltet die Limestone-Optik von Lims jedes Ambiente warm und natürlich. Sorgfältig ausgeführte, realistische Texturdetails sowie stofflich wirkende Bearbeitungen lassen Oberflächen entstehen, die den mit klassischen Handwerkstechniken bearbeiteten Naturstein reproduzieren.

Богатый рисунок известняка, воссозданный в коллекции Lims, вдыхает в интерьер натуральное тепло. Реалистичные детали и выразительная фактурность создают на поверхности эффект обработанного природного камня.



INDEX



OVERVIEW



IMAGE GALLERY



CONTEMPORARY LIVING
Beige Ivory

SWIMMING POOL VILLA
Beige

DESIGN LIBRARY CAFÉ
Grey

CHARME RESORT
Desert Ivory

HOME BATHROOM
Ivory

HOTEL RESTROOM
Beige

PRODUCT RANGE & TECHNICAL SPECS.

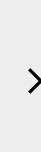

SUSTAINABILITY



THE BENEFITS OF CERAMIC TILES



© Ceramiche Atlas Concorde

FLOOR
Lims **Beige** Matte/Matt
75x150 cm | 29 1/2" x 59"

Heartwood **Malt** Matte/Matt
18,5x150 cm | 7 1/4" x 59"

WALL
Lims **Ivory** Matte/Matt
75x150 cm | 29 1/2" x 59"





WALL

Lims **Ivory Bush Hammered**
37,5x75 cm | 14³/₄" x 29¹/₂"

Lims **Beige Line**
37,5x75 cm | 14³/₄" x 29¹/₂"



© Ceramiche Atlas Concorde

LINE AND BUSH-HAMMERED FINISHES ARE INSPIRED BY THE LOOK OF NATURAL WORKED STONE AND GIVE AN EARTHY TOUCH TO FLOORS AND WALLS, BOTH INDOORS AND OUT.

LE FINITURE LINE E BUSH-HAMMERED SI ISPIRANO ALLE LAVORAZIONI DELLE PIETRE NATURALI E INFONDONO UN TOCCO MATERICO A PAVIMENTI E RIVESTIMENTI A PARETE, SIA NEGLI AMBIENTI INTERNI CHE NEGLI AMBIENTI ESTERNI.

LES FINITIONS LINE ET BUSH-HAMMERED S'INSPIRENT DES DIFFÉRENTS FAÇONNAGES DES PIERRES NATURELLES ET CONFÈRENT UN ASPECT SUPERBE AUX SOLS ET AUX MURS, SOIT EN INTÉRIEUR QU'EN EXTÉRIEUR.

DIE OBERFLÄCHENVERSIONEN LINE UND BUSH-HAMMERED SIND AN NATURSTEINBEARBEITUNGEN INSPIRIERT UND LASSEN WAND- UND BODENBELÄGE STOFFLICH WIRKEN. FÜR INNEN UND AUSSEN.

LOS ACABADOS LINE Y BUSH-HAMMERED SE INSPIRAN EN LAS ELABORACIONES DE PIEDRAS NATURALES Y DAN UN TOQUE MATERIAL A LOS PAVIMENTOS Y REVESTIMIENTOS PARA PAREDES, TANTO EN AMBIENTES INTERIORES COMO EXTERIORES.

ПОВЕРХНОСТИ LINE И BUSH-HAMMERED ИМИТИРУЮТ ФАКТУРУ ОБРАБОТАННОГО ПРИРОДНОГО КАМНЯ И ПОДХОДЯТ ДЛЯ ОФОРМЛЕНИЯ ПОЛОВ И СТЕН ВНУТРИ ПОМЕЩЕНИЙ И НА УЛИЦЕ.



INDEX



OVERVIEW



IMAGE GALLERY



CONTEMPORARY LIVING
Beige Ivory

SWIMMING POOL VILLA
Beige

DESIGN LIBRARY CAFÉ
Grey

CHARME RESORT
Desert Ivory

HOME BATHROOM
Ivory

HOTEL RESTROOM
Beige

PRODUCT RANGE & TECHNICAL SPECS.

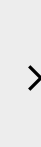

SUSTAINABILITY



THE BENEFITS OF CERAMIC TILES

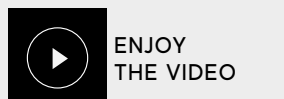

THE STONE-EFFECT MOSAICO GEMINI CREATES A SOFT AND DECIDEDLY CONTEMPORARY DESIGN. FOR USE ON BOTH FLOORS AND WALLS.

IL MOSAICO GEMINI EFFETTO PIETRA CREA UN DISEGNO MORBIDO E DECISAMENTE CONTEMPORANEO. PER UN USO SIA A PAVIMENTO CHE A PARETE.

LE DÉCOR MOSAICO GEMINI EFFET PIERRE CRÉE UN DESSIN DÉLICAT EXTRÊMEMENT CONTEMPORAIN. POUR UNE POSE AU SOL OU AU MUR.

DAS MOSAICO GEMINI IN NATURSTEINOPTIK ERZEUGT EIN WEICHES UND HOCHMODERNES MUSTER. ZUR VERLEGUNG AN WAND UND BODEN.

EL MOSAICO GEMINI EFECTO PIEDRA CREA UN DISEÑO SUAVE Y DEFINITIVAMENTE CONTEMPORÁNEO. PARA SU USO TANTO EN PAVIMENTOS COMO EN REVESTIMIENTOS.

МОЗАИКА GEMINI С ФАКТУРОЙ КАМНЯ СОЗДАЕТ МЯГКИЙ СОВРЕМЕННЫЙ РИСУНОК ОБЛИЦОВКИ. ПОДХОДИТ КАК ДЛЯ ПОЛОВ, ТАК И ДЛЯ СТЕН.

FLOOR

Lims **Beige** Mosaico Gemini
41,6x24 cm | 12 1/4" x 9 1/2"

Heartwood **Malt** Matte/Matt
18,5x150 cm | 7 1/4" x 59"

WALL

Lims **Beige** Mosaico Gemini
41,6x24 cm | 12 1/4" x 9 1/2"



© Ceramiche Atlas Concorde



© Ceramiche Atlas Concorde

INDEX



OVERVIEW



IMAGE GALLERY



CONTEMPORARY LIVING
Beige Ivory

SWIMMING POOL VILLA
Beige

DESIGN LIBRARY CAFÉ
Grey

CHARME RESORT
Desert Ivory

HOME BATHROOM
Ivory

HOTEL RESTROOM
Beige

PRODUCT RANGE & TECHNICAL SPECS.



SUSTAINABILITY



THE BENEFITS OF CERAMIC TILES

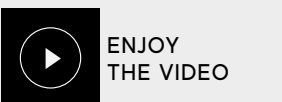



© Ceramiche Atlas Concorde

FLOOR

Lims **Beige** Matte/Matt
75x150 cm | 29 1/2" x 59"

Heartwood **Malt** Matte/Matt
18,5x150 cm | 7 1/4" x 59"

WALL

Lims **Ivory** Bush Hammered
37,5x75 cm | 14 3/4" x 29 1/2"

Lims **Ivory** Matte/Matt
75x150 cm | 29 1/2" x 59"

INDEX



OVERVIEW



IMAGE GALLERY



CONTEMPORARY LIVING
Beige Ivory

SWIMMING POOL VILLA
Beige

DESIGN LIBRARY CAFÉ
Grey

CHARME RESORT
Desert Ivory

HOME BATHROOM
Ivory

HOTEL RESTROOM
Beige

PRODUCT
RANGE &
TECHNICAL
SPECS.



SUSTAINABILITY



THE BENEFITS OF
CERAMIC TILES

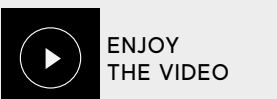

THE CONTINUITY AND NATURAL CHARACTER OF THE WARM STONE EFFECT CONNECTS THE INDOORS AND OUTDOORS THANKS TO THE USE OF PERFECTLY COORDINATED SURFACES.

LA CONTINUITÀ E NATURALITÀ DEL CALDO EFFETTO PIETRA SI ESTENDE TRA L'INTERNO E L'ESTERNO GRAZIE ALL'UTILIZZO DI SUPERFICI PERFETTAMENTE COORDINATE.

LA CHALEUR NATURELLE DE L'EFFET PIERRE S'ÉTEND EN CONTINUITÉ ENTRE L'INTÉRIEUR ET L'EXTÉRIEUR GRÂCE À L'UTILISATION DE SURFACES PARFAITEMENT COORDONNÉES.

DIE KONTINUITÄT UND NATÜRLICHKEIT DER WARMEN STEINOPTIK ERSTRECKT SICH DURCHGÄNGIG VON INNEN NACH AUSSEN, DA DIE OBERFLÄCHEN PERFECT AUF EINANDER ABGESTIMMT SIND.

LA CONTINUIDAD Y NATURALIDAD DEL CÁLIDO EFECTO PIEDRA SE EXTIENDE EN CONTINUIDAD ENTRE EL INTERIOR Y EL EXTERIOR GRACIAS AL USO DE SUPERFICIES PERFECTAMENTE COMBINADAS.

НАТУРАЛЬНОСТЬ И ТЕПЛО ФАКТУРЫ КАМНЯ ЕСТЕСТВЕННО ТЯНУТСЯ ИЗ ДОМА НА УЛИЦУ БЛАГОДАРЯ ИСПОЛЬЗОВАНИЮ ПЛИТКИ С ОДИНАКОВЫМ РИСУНКОМ ПОВЕРХНОСТИ.

OUTDOOR

Lims **Beige** Grip
37,5x75 cm | 14³/₄" x 29¹/₂"

Lims **Beige** Matte/Matt
75x150 cm | 29¹/₂" x 59"



© Ceramiche Atlas Concorde

INDEX



OVERVIEW



IMAGE GALLERY



CONTEMPORARY LIVING
Beige Ivory

SWIMMING POOL VILLA
Beige

DESIGN LIBRARY CAFÉ
Grey

CHARME RESORT
Desert Ivory

HOME BATHROOM
Ivory

HOTEL RESTROOM
Beige

PRODUCT
RANGE &
TECHNICAL
SPECS.



SUSTAINABILITY



THE BENEFITS OF
CERAMIC TILES



ENJOY
THE VIDEO



© Ceramiche Atlas Concorde

OUTDOOR
 Lims **Beige Grip**
 37,5x75 cm | 14³/₄" x 29¹/₂"
 Lims **Beige Matte/Matt**
 75x150 cm | 29¹/₂" x 59"



© Ceramiche Atlas Concorde

INDEX



OVERVIEW



IMAGE GALLERY



CONTEMPORARY LIVING
Beige Ivory

SWIMMING POOL VILLA
Beige

DESIGN LIBRARY CAFÉ
Grey

CHARME RESORT
Desert Ivory

HOME BATHROOM
Ivory

HOTEL RESTROOM
Beige

PRODUCT RANGE & TECHNICAL SPECS.



SUSTAINABILITY



THE BENEFITS OF CERAMIC TILES



02 SIMPLE, NATURAL STYLE



CONTEMPORARY LIVING
Beige Ivory

SWIMMING POOL VILLA
Beige

DESIGN LIBRARY CAFÉ
Grey

CHARME RESORT
Desert Ivory

HOME BATHROOM
Ivory

HOTEL RESTROOM
Beige

PRODUCT
RANGE &
TECHNICAL
SPECS.



SUSTAINABILITY



THE BENEFITS OF
CERAMIC TILES



ENJOY
THE VIDEO



The natural, luminous stone effect extends with stylistic continuity from inside to outside, designing spaces with an essential and welcoming style. The shades are inspired by warm limestone for indoor and outdoor spaces in sync with current interior design trends.

L'effetto pietra naturale e luminoso si estende con continuità stilistica dall'interno all'esterno, disegnando spazi dallo stile essenziale e accogliente. Le tonalità sono ispirate a pietre calcaree calde per spazi indoor e outdoor in linea con le attuali tendenze dell'interior design.

L'effet pierre lumineux et naturel s'étend en continuité stylistique de l'intérieur à l'extérieur, en dessinant des espaces au style minimaliste et accueillant. Les teintes s'inspirent de pierres calcaires aux tons chauds pour réaliser des espaces intérieurs et extérieurs en accord avec les dernières tendances du design d'intérieur.

Natürliche, helle Steinoptik erstreckt sich mit stilistischer Kontinuität von innen nach außen und lässt ein Ambiente von schlicht-behaglichem Stil entstehen. Die Farbtöne sind an warmen Kalksteinen für Innen- und Außenbereiche inspiriert und entsprechen den aktuellen Trends des Innendesigns.

El efecto piedra natural y luminoso se extiende con continuidad estilística desde el interior al exterior, diseñando espacios con un estilo esencial y acogedor. Las tonalidades están inspiradas en piedras calcáreas cálidas para espacios interiores y exteriores, perfectamente alineadas a las tendencias actuales de diseño de interiores.

Светлый и лаконичный рисунок природного камня связывает внутренние и наружные пространства в одно гармоничное целое. Теплые тона переняты у известняков и отражают последние тенденции в дизайне интерьера.

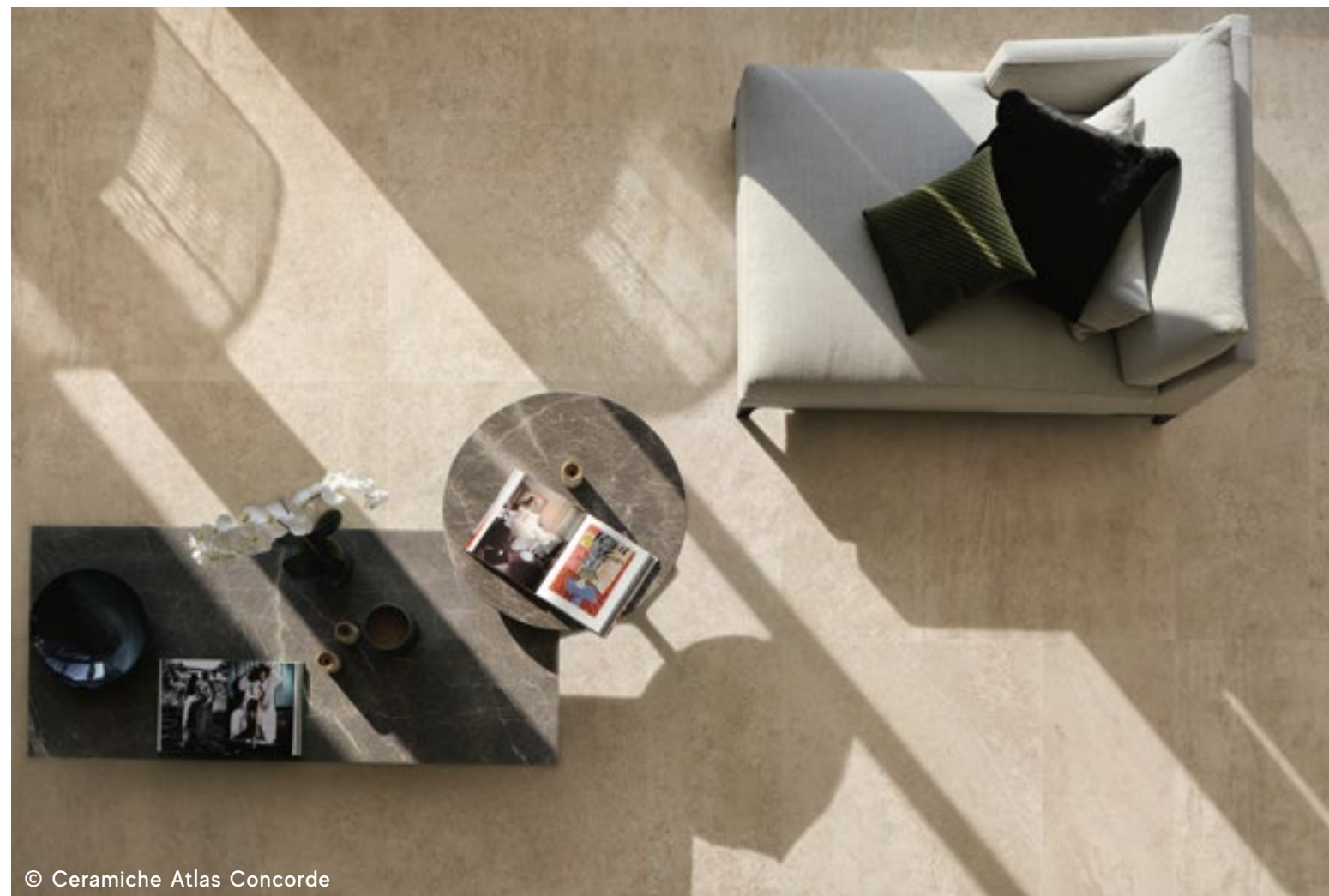

© Ceramiche Atlas Concorde

THE 37.5x75 cm AND 75x75 cm SIZES ARE MODULAR AND ALLOW FOR THE TYPICAL LAYING PATTERNS OF NATURAL STONE.

LES FORMATS 37,5x75 cm ET 75x75 cm SONT MODULAIRES ET PERMETTENT DE RÉALISER DES SCHÉMAS DE POSE TYPIQUES DES PIERRES NATURELLES.

LOS FORMATOS 37,5x75 cm Y 75x75 cm SON MODULARES Y PERMITEN LOS TÍPICOS PATRONES DE COLOCACIÓN DE LA PIEDRA NATURAL.

I FORMATI 37,5x75 cm E 75x75 cm SONO MODULARI E CONSENTONO DI REALIZZARE GLI SCHEMI DI POSA TIPICI DELLE PIETRE NATURALI.

DIE FORMATE 37,5x75 cm UND 75x75 cm SIND MODULAR UND ERLAUBEN DIE AUSFÜHRUNG VON FÜR NATURSTEINE TYPISCHEN VERLEGEMUSTERN.

МОДУЛЬНЫЕ ФОРМАТЫ 37,5x 75 см И 75x75 см ПОЗВОЛЯЮТ ВЫСТРАИВАТЬ ХАРАКТЕРНЫЕ ДЛЯ ПРИРОДНОГО КАМНЯ РИСУНКИ УКЛАДКИ.

FLOOR

Lims **Beige** Matte/Matt
37,5x75 cm | 14³/₄" x 29¹/₂"

Lims **Beige** Matte/Matt
75x75 cm | 29¹/₂" x 29¹/₂"



© Ceramiche Atlas Concorde

INDEX



OVERVIEW



IMAGE GALLERY



CONTEMPORARY LIVING
Beige Ivory

SWIMMING POOL VILLA
Beige

DESIGN LIBRARY CAFÉ
Grey

CHARME RESORT
Desert Ivory

HOME BATHROOM
Ivory

HOTEL RESTROOM
Beige

PRODUCT RANGE & TECHNICAL SPECS.



SUSTAINABILITY



THE BENEFITS OF CERAMIC TILES

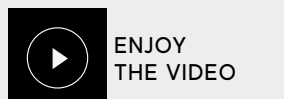



© Ceramiche Atlas Concorde

THE BUSH-HAMMERED SURFACE HAS A CORRUGATED TEXTURE TYPICAL OF NATURAL STONework. ON THE FLOOR IT RECREATES THE EARTHY, NATURAL EFFECT OF WORKED STONE, WHILE ON THE WALL IT ADDS A DECORATIVE TOUCH.

LA SUPERFICIE BOCCIARDATA HA UNA STRUTTURA CORRUGATA TIPICA DELLE LAVORAZIONI DELLE PIETRE NATURALI; A PAVIMENTO RICREA L'EFFETTO MATERICO-NATURALE DELLA PIETRA LAVORATA, MENTRE A PARETE AGGIUNGE UN TOCCO DECORATIVO.

LA SURFACE BOUCHARDÉE PRÉSENTE UNE STRUCTURE LÉGÈREMENT RUGUEUSE TYPIQUE DES DIFFÉRENTS FAÇONNAGES DES PIERRES NATURELLES ; SUR LE SOL, ELLE RECRÉE L'EFFET DE TEXTURE NATURELLE DE LA PIERRE FAÇONNÉE ET APORTE UNE TOUCHE DÉCORATIVE QUAND ELLE EST POSÉE SUR LE MUR.

DIE GEKRÖNELTE OBERFLÄCHE HAT EINE FÜR BEARBEITETEN NATURSTEIN TYPISCHE, GENARBTE STRUKTUR. AM BODEN EMPFINDET SIE DIE STOFFLICH-NATÜRLICHE OPTIK DES BEARBEITETEN STEINS NACH; AN DER WAND WIRKT SIE BESONDERS DEKORATIV.

LA SUPERFICIE ABUJARDADA TIENE UNA ESTRUCTURA CORRUGADA TÍPICA DE LA ELABORACIÓN DE LAS PIEDRAS NATURALES; EN EL PAVIMENTO RECREA EL EFECTO MATERIAL-NATURAL DE LA PIEDRA ELABORADA, MIENTRAS QUE EN LA PARED AÑADE UN TOQUE DECORATIVO.

БУЧАРДИРОВАННАЯ ПОВЕРХНОСТЬ ИМЕЕТ ШЕРОХОВАТУЮ СТРУКТУРУ, ХАРАКТЕРНУЮ ДЛЯ ОБРАБОТАННОГО ПРИРОДНОГО КАМНЯ. ПОЛАМ ОНА ПРИДАЕТ ВЫРАЗИТЕЛЬНУЮ ФАКТУРНУЮ, СТЕНАМ – ЭФФЕКТНУЮ ДЕКОРАТИВНОСТЬ.

FLOOR

Lims **Beige** Matte/Matt
37,5x75 cm | 14³/₄" x 29¹/₂"

Lims **Beige** Matte/Matt
75x75 cm | 29¹/₂" x 29¹/₂"

Lims **Desert** Bush Hammered
37,5x75 cm | 14³/₄" x 29¹/₂"

WALL

Lims **Beige** Matte/Matt
120x278 cm | 47¹/₄" x 109¹/₂"



INDEX



OVERVIEW



IMAGE GALLERY



CONTEMPORARY LIVING
Beige Ivory

SWIMMING POOL VILLA
Beige

DESIGN LIBRARY CAFÉ
Grey

CHARME RESORT
Desert Ivory

HOME BATHROOM
Ivory

HOTEL RESTROOM
Beige

PRODUCT
RANGE &
TECHNICAL
SPECS.



SUSTAINABILITY



THE BENEFITS OF
CERAMIC TILES



© Ceramiche Atlas Concorde



© Ceramiche Atlas Concorde

PORCELAIN TILES WITH A NON-SLIP FINISH ARE PARTICULARLY SUITABLE FOR FLOORS IN WET OR DAMP OUTDOOR SPACES SUCH AS SWIMMING POOLS AND SOLARIUMS, WHICH REQUIRE MATERIALS THAT MEET SPECIFIC SAFETY REQUIREMENTS.

IL GRES PORCELLANATO CON FINITURA ANTISCIVOLO È PARTICOLARMENTE INDICATO NELLE APPLICAZIONI A PAVIMENTO DI SPAZI ESTERNI UMIDI O BAGNATI COME PISCINE E SOLARIUM, CHE RICHIEDONO MATERIALI CON SPECIFICI REQUISITI DI SICUREZZA.

LE GRÈS CÉRAME ANTIDÉRAPANT EST PARTICULIÈREMENT INDIQUÉ POUR LE SOL DES ESPACES EXTÉRIEURS HUMIDES OU MOUILLÉS, TELS QUE LES PISCINES ET LES SOLARIUMS QUI NÉCESSITENT DE MATÉRIAUX RESPECTANT DES EXIGENCES DE SÉCURITÉ SPÉCIFIQUES.

FEINSTEINZEUG MIT RUTSCHFESTER OBERFLÄCHE EIGNET SICH BESONDERS GUT FÜR BODENBELÄGE IN FEUCHTEN ODER NASSEN AUSSENBEREICHEN WIE SWIMMING-POOLS UND SOLARIEN, DIE MATERIALIEN MIT SPEZIFISCHEN SICHERHEITSMERKMALEN ERFORDERN.

EL GRES PORCELÁNICO CON ACABADO ANTIDESLIZANTE ES PARTICULARMENTE ADECUADO PARA APLICACIONES EN EL PAVIMENTO DE ESPACIOS EXTERIORES HÚMEDOS O MOJADOS COMO PISCINAS Y SOLARIUMS, QUE REQUIEREN MATERIALES CON REQUISITOS DE SEGURIDAD ESPECÍFICOS.

КЕРАМОГРАНИТ С ПРОТИВОСКОЛЬЗЯЩЕЙ ПОВЕРХНОСТЬЮ ОСОБЕННО РЕКОМЕНДОВАН ДЛЯ УСТРОЙСТВА УЛИЧНЫХ ПОКРЫТИЙ ВО ВЛАЖНЫХ МЕСТАХ, ТАКИХ КАК БАССЕЙНЫ ИЛИ АЭРОСОЛЯРИИ, ГДЕ ОТ МАТЕРИАЛОВ ТРЕБУЮТСЯ ВЫСОКИЕ ПОКАЗАТЕЛИ БЕЗОПАСНОСТИ.

OUTDOOR

Lims **Beige** Outdoor \pm 20 mm
60x120 cm | 23⁵/₈" x 47¹/₄"

Lims **Beige** Brick
37,5x75 cm | 14³/₄" x 29¹/₂"



© Ceramiche Atlas Concorde

INDEX



OVERVIEW



IMAGE GALLERY



CONTEMPORARY LIVING
Beige Ivory

SWIMMING POOL VILLA
Beige

DESIGN LIBRARY CAFÉ
Grey

CHARME RESORT
Desert Ivory

HOME BATHROOM
Ivory

HOTEL RESTROOM
Beige

PRODUCT RANGE & TECHNICAL SPECS.



SUSTAINABILITY



THE BENEFITS OF CERAMIC TILES



03 BROAD CONTEMPORARY SPACES



CONTEMPORARY LIVING
Beige Ivory

SWIMMING POOL VILLA
Beige

DESIGN LIBRARY CAFÉ
Grey

CHARME RESORT
Desert Ivory

HOME BATHROOM
Ivory

HOTEL RESTROOM
Beige

PRODUCT
RANGE &
TECHNICAL
SPECS.



SUSTAINABILITY



THE BENEFITS OF
CERAMIC TILES



ENJOY
THE VIDEO

The large stone-effect slabs of Lims are inspired by the rich graphics of limestones from all over the world. The large porcelain tile formats create visual continuity and are ideal for the design of multifunctional public spaces with a contemporary style.

Le grandi lastre effetto pietra di Lims sono ispirate alla ricca grafica di limestone provenienti da tutto il mondo. I grandi formati in gres porcellanato creano continuità visiva e sono ideali per la progettazione di spazi pubblici plurifunzionali dallo stile contemporaneo.

Les grandes plaques effet pierre de Lims s'inspirent de la richesse graphique de pierres limestone provenant du monde entier. Les grands formats en grès cérame créent une continuité visuelle et sont parfaits pour la conception d'espaces publics polyfonctionnels au style contemporain.

Die großen Platten in Natursteinoptik von Lims sind an der reichen Grafik von Kalksteinen, Limestones, aus aller Welt inspiriert. Das großformatige Feinsteinzeug sorgt für optische Kontinuität und ist ideal für die Planung öffentlicher Mehrzweckbereiche von kontemporärem Stil.

Las grandes placas con efecto piedra de Lims están inspiradas en los ricos gráficos de limestone provenientes de todo el mundo. Los grandes formatos de gres porcelánico crean una continuidad visual y son ideales para el diseño de espacios públicos multifuncionales con estilo contemporáneo.

Большие плиты под камень коллекции Lims воссоздают богатый рисунок известняков со всего мира. Крупные форматы керамогранита рожают эффект цельности облицовки и идеальны для оформления многофункциональных пространств в современном стиле.



© Ceramiche Atlas Concorde

PORCELAIN TILES ARE IDEAL FOR HIGH-TRAFFIC ENVIRONMENTS THANKS TO THEIR HIGH BREAKING LOAD AND THE HYGIENE GUARANTEED BY EASY CLEANING AND MAINTENANCE.

IL GRES PORCELLANATO È IDEALE PER AMBIENTI CON UN'ELEVATA PRESENZA DI VISITATORI GRAZIE AL SUO ELEVATO CARICO DI ROTTURA E ALLA IGIENICITÀ GARANTITA DALLA FACILITÀ DI PULIZIA E MANUTENZIONE.

LE GRÈS CÉRAME EST L'IDÉAL DANS LES LIEUX À FORTE AFFLUENCE DE VISITEURS, GRÂCE À SA HAUTE CHARGE DE RUPTURE ET À SON HYGIÈNE QUI EST GARANTIE PAR SA GRANDE FACILITÉ D'ENTRETIEN.

FEINSTEINZEUG IST DANK SEINER HOHEN BRUCHLAST UND DER DURCH DIE EINFACHE REINIGUNG UND PFLEGE GARANTIERTEN HYGIENE FÜR VIELBESUCHTE RÄUME IDEAL.

EL GRES PORCELÁNICO ES IDEAL PARA AMBIENTES CON GRAN PRESENCIA DE VISITANTES GRACIAS A SU ALTA CARGA DE ROTURA Y A LA HIGIENE GARANTIZADA POR SU FÁCIL LIMPIEZA Y MANTENIMIENTO.

КЕРАМОГРАНИТ ИДЕАЛЕН ДЛЯ ПОМЕЩЕНИЙ С БОЛЬШИМ КОЛИЧЕСТВОМ ПОСЕТИТЕЛЕЙ БЛАГОДАРЯ ВЫСОКОЙ СТОЙКОСТИ К РАЗРЫВУ, ГИГИЕНИЧНОСТИ, ПРОСТОТЕ ЧИСТКИ И УХОДА.



© Ceramiche Atlas Concorde

FLOOR
Lims Grey Matte/Matt
120x120 cm | 47 1/4" x 47 1/4"

WALL
Lims Grey Matte/Matt
120x278 cm | 47 1/4" x 109 1/2"

INDEX



OVERVIEW



IMAGE GALLERY



CONTEMPORARY LIVING
Beige Ivory

SWIMMING POOL VILLA
Beige

DESIGN LIBRARY CAFÉ
Grey

CHARME RESORT
Desert Ivory

HOME BATHROOM
Ivory

HOTEL RESTROOM
Beige

PRODUCT RANGE & TECHNICAL SPECS.



SUSTAINABILITY



THE BENEFITS OF CERAMIC TILES

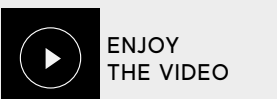



© Ceramiche Atlas Concorde

FLOOR

Lims **Grey Matte/Matt**
120x120 cm | 47 1/4" x 47 1/4"

WALL

Lims **Grey Matte/Matt**
120x278 cm | 47 1/4" x 109 1/2"

Lims **Grey Matte/Matt**
120x120 cm | 47 1/4" x 47 1/4"



© Ceramiche Atlas Concorde

INDEX



OVERVIEW



IMAGE GALLERY



CONTEMPORARY LIVING
Beige Ivory

SWIMMING POOL VILLA
Beige

DESIGN LIBRARY CAFÉ
Grey

CHARME RESORT
Desert Ivory

HOME BATHROOM
Ivory

HOTEL RESTROOM
Beige

PRODUCT RANGE & TECHNICAL SPECS.



SUSTAINABILITY



THE BENEFITS OF CERAMIC TILES

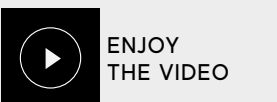



IN THE MOSAICO SPRITZ, THE SMALL RECTANGLES WITH IRREGULAR EDGES TYPICAL OF SPLIT STONE CREATE AN EFFECT THAT IS BOTH NATURAL AND ELEGANT.

NEL MOSAICO SPRITZ, I PICCOLI RETTANGOLI DAI BORDI IRREGOLARI, TIPICI DELLE LAVORAZIONI A SPACCO, CREANO UN EFFETTO NATURALE ED ELEGANTE AL TEMPO STESSO.

DANS LE DÉCOR MOSAICO SPRITZ, DE PETITS RECTANGLES AUX FORMES ET AUX BORDS IRRÉGULIERS, TYPIQUES DU FAÇONNAGE À L'ANCIENNE, CRÉENT UN EFFET À LA FOIS NATUREL ET ÉLÉGAN.

IM MOSAICO SPRITZ ERZEUGEN KLEINE RECHTECKE MIT UNREGELMÄSSIGEN KANTEN, WIE SIE DURCH DAS SPALTEN DER STEINE ENTSTEHEN, EINE NATÜRLICHE UND ZUGLEICH ELEGANTE WIRKUNG.

EN MOSAICO SPRITZ, LAS TESELAS DE SUPERFICIE NATURAL SE MEZCLAN ALEATORIAMENTE CON OTRAS DE SUPERFICIE ABUJARDADA, CREANDO UN EFECTO DE DINAMISMO Y NATURALIDAD.

В МОЗАИКЕ SPRITZ ПЕРЕМЕШАННЫЕ ЭЛЕМЕНТЫ С НАТУРАЛЬНОЙ И БУЧАРДИРОВАННОЙ ПОВЕРХНОСТЬЮ СОЗДАЮТ ИНТЕРЕСНЫЙ ЭФФЕКТ ДИНАМИЗМА.

WALL
Lims **Grey** Mosaico Spritz
29x32,3 cm | 11³/₈" x 12³/₄"



THE BRICK DECORATION CAN BE USED INDOORS AND OUTDOORS ON BOTH WALLS AND FLOORS.

IL DECORO BRICK PUÒ ESSERE USATO IN INTERNO E IN ESTERNO, SIA A PARETE CHE A PAVIMENTO.

LE DÉCOR BRICK PEUT ÊTRE UTILISÉ EN INTÉRIEUR ET EN EXTÉRIEUR, SOIT SUR LE MUR QUE SUR LE SOL.

DAS DEKOR BRICK KANN INNEN WIE AUSSEN, AN WAND UND BODEN VERLEGT WERDEN.

LA DECORACIÓN BRICK PUEDE SER USADA EN INTERIORES Y EXTERIORES, TANTO EN PAREDES COMO EN PAVIMENTOS.

ДЕКОР BRICK МОЖЕТ БЫТЬ УЛОЖЕН ВНУТРИ ПОМЕЩЕНИЙ И НА УЛИЦЕ, НА СТЕНАХ И ПОЛАХ.

OUTDOOR
Lims **Grey** Outdoor \pm 20 mm
60x120 cm | 23⁵/₈" x 47¹/₄"

Lims **Grey** Brick
37,5x75 cm | 14³/₄" x 29¹/₂"



INDEX



OVERVIEW



IMAGE GALLERY



CONTEMPORARY LIVING
Beige Ivory

SWIMMING POOL VILLA
Beige

DESIGN LIBRARY CAFÈ
Grey

CHARME RESORT
Desert Ivory

HOME BATHROOM
Ivory

HOTEL RESTROOM
Beige

PRODUCT
RANGE &
TECHNICAL
SPECS.



SUSTAINABILITY



THE BENEFITS OF
CERAMIC TILES

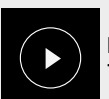

ENJOY
THE VIDEO

04 CONTINUITY INSIDE AND OUT



INDEX



OVERVIEW



IMAGE GALLERY

CONTEMPORARY LIVING
Beige IvorySWIMMING POOL VILLA
BeigeDESIGN LIBRARY CAFÉ
GreyCHARME RESORT
Desert IvoryHOME BATHROOM
IvoryHOTEL RESTROOM
BeigePRODUCT
RANGE &
TECHNICAL
SPECS.

SUSTAINABILITY

THE BENEFITS OF
CERAMIC TILES
 ENJOY
THE VIDEO

Porcelain tiles inspired by limestone in warm, intense colors are ideal for the design of spaces that require visual and stylistic harmony and continuity between indoor and outdoor environments thanks to the presence of perfectly coordinated surfaces.

Il gres porcellanato ispirato a pietre limestone dai colori caldi e intensi è ideale per la progettazione di spazi che richiedono armonizzazione e continuità visiva e stilistica tra ambienti interni ed esterni, grazie alla presenza di superfici perfettamente coordinate.

Le grès cérame qui s'inspire des pierres limestone aux tons chauds et intenses est l'idéal pour la conception des espaces qui exigent une harmonisation et une continuité visuelle et stylistique entre l'intérieur et l'extérieur, grâce à la présence de surfaces parfaitement coordonnées.

An Kalksteinen – Limestones – in warmen, satten Farben inspiriertes Feinsteinzeug ist dank der perfekt aufeinander abgestimmten Oberflächen ideal für die Planung von Bereichen, in denen In- und Outdoor harmonisch sowie in optischer und stilistischer Kontinuität aufeinander abgestimmt werden soll.

El gres porcelánico inspirado en las piedras limestone con colores cálidos e intensos es ideal para el diseño de espacios que requieren armonización y continuidad visual y estilística entre los ambientes interiores y exteriores, gracias a la presencia de superficies perfectamente coordinadas.

Керамогранит теплых тонов под известняк идеален для оформления внутренних и наружных пространств в едином стиле благодаря превосходной сочетаемости поверхностей.



© Ceramiche Atlas Concorde



58 © Ceramiche Atlas Concorde



© Ceramiche Atlas Concorde

FLOOR

Lims **Desert** Matte/Matt
37,5x75 cm | 14³/₄" x 29¹/₂"

Lims **Desert** Matte/Matt
75x75 cm | 29¹/₂" x 29¹/₂"

Lims **Desert** Matte/Matt
75x150 cm | 29¹/₂" x 59"

WALL

Lims **Ivory** Matte/Matt
120x278 cm | 47¹/₄" x 109¹/₂"

Lims **Desert** Matte/Matt
120x278 cm | 47¹/₄" x 109¹/₂"

THE DESERT AND IVORY TONES USED ON THE WALLS INTERACT IN PERFECT CHROMATIC HARMONY.

I TONI DESERT E IVORY USATI NEI RIVESTIMENTI DIALOGANO IN PERFETTA ARMONIA CROMATICA.

LES TONS DESERT ET IVORY UTILISÉS DIALOGUENT EN PARFAITE HARMONIE CHROMATIQUE.

DIE FARBTÖNE DESERT UND IVORY DER WANDBELÄGE DIALOGIEREN IN PERFEKTER FARBLICHER HARMONIE.

LOS TONOS DESERT E IVORY UTILIZADOS EN LOS REVESTIMIENTOS CREAN UN DIÁLOGO DE PERFECTA ARMONÍA CROMÁTICA.

ТОНА DESERT И IVORY НА СТЕНАХ ВЕЛИКОЛЕПНО ГАРМОНИРУЮТ МЕЖДУ СОБОЙ.



59

INDEX



OVERVIEW



IMAGE GALLERY



CONTEMPORARY LIVING
Beige Ivory

SWIMMING POOL VILLA
Beige

DESIGN LIBRARY CAFÉ
Grey

CHARME RESORT
Desert Ivory

HOME BATHROOM
Ivory

HOTEL RESTROOM
Beige

PRODUCT RANGE & TECHNICAL SPECS.

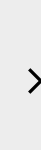

SUSTAINABILITY



THE BENEFITS OF CERAMIC TILES





FLOOR

Lims **Desert** Matte/Matt
75x75 cm | 29 1/2" x 29 1/2"

Lims **Desert** Matte/Matt
75x150 cm | 29 1/2" x 59"

WALL

Lims **Ivory** Matte/Matt
120x278 cm | 47 1/4" x 109 1/2"

Lims **Desert** Matte/Matt
120x278 cm | 47 1/4" x 109 1/2"

Boost Pro **Leaves** Matte/Matt
120x278 cm | 47 1/4" x 109 1/2"

© Ceramiche Atlas Concorde

INDEX



OVERVIEW



IMAGE GALLERY



CONTEMPORARY LIVING
Beige Ivory

SWIMMING POOL VILLA
Beige

DESIGN LIBRARY CAFÉ
Grey

CHARME RESORT
Desert Ivory

HOME BATHROOM
Ivory

HOTEL RESTROOM
Beige

PRODUCT RANGE & TECHNICAL SPECS.



SUSTAINABILITY



THE BENEFITS OF CERAMIC TILES





© Ceramiche Atlas Concorde



© Ceramiche Atlas Concorde

LIMS CREATES MODERN OUTDOOR SPACES MADE UNALTERABLE BY THE PERFORMANCE OF PORCELAIN TILES. IN FACT, THE SURFACES STAND UP TO WEATHER, UV RAYS, AND CONTACT WITH SALT OR CHLORINE.

LIMS CREA SPAZI OUTDOOR MODERNI RESI INALTERABILI DALLE PRESTAZIONI DEL GRES PORCELLANATO: LE SUPERFICI, INFATTI, RESISTONO ALL'ESPOSIZIONE AGLI AGENTI ATMOSFERICI, AI RAGGI UV E AL CONTATTO CON SALE O CLORO.

LIMS CRÉE DES ESPACES EXTÉRIEURS MODERNES RENDUS INALTÉRABLES GRÂCE AUX PERFORMANCES DU GRÈS CÉRAMÉ : EN EFFET, CES SURFACES RÉSENT À L'EXPOSITION AUX AGENTS ATMOSPHÉRIQUES, AUX RAYONS UV ET AU CONTACT AVEC LE SEL ET LE CHLORE.

LIMS ERZEUGT MODERNE AUSSENBEREICHE, DIE DANK DER LEISTUNGEN DES FEINSTEINZEUGS FÜR IMMER SCHÖN BLEIBEN: DIE OBERFLÄCHEN SIND GEGEN WITTERUNG, UV-STRAHLEN UND DEN KONTAKT MIT SALZ UND CHLOR BESTÄNDIG.

LIMS CREA MODERNOS ESPACIOS EXTERIORES QUE SE VUELVEN INALTERABLES GRACIAS AL RENDIMIENTO DEL GRES PORCELÁNICO. DE HECHO, LAS SUPERFICIES RESISTEN A LA EXPOSICIÓN A LA INTEMPERIE, LOS RAYOS UV Y EL CONTACTO CON SAL O CLORO.

ПРОСТРАНСТВА, ОФОРМЛЕННЫЕ КЕРАМОГРАНИТОМ LIMS, СОХРАНЯЮТ СВОЙ ПЕРВОНАЧАЛЬНЫЙ ВИД ДАЖЕ ПО ПРОШЕСТВИИ ДОЛГОГО ВРЕМЕНИ: ПОВЕРХНОСТЬ ПЛИТОК КРАЙНЕ УСТОЙЧИВА К ВОЗДЕЙСТВИЮ АТМОСФЕРНЫХ ФАКТОРОВ, УЛЬТРАФИОЛЕТА, СОЛЕЙ, ХЛОРА.

OUTDOOR

Lims **Desert** Outdoor \times 20 mm
60x120 cm | 23⁵/₈" x 47¹/₄"

Lims **Ivory** Matte/Matt
120x278 cm | 47¹/₄" x 109¹/₂"

COUNTERTOP

Lims **Desert** Matte/Matt
120x278 cm | 47¹/₄" x 109¹/₂"



© Ceramiche Atlas Concorde

INDEX



OVERVIEW



IMAGE GALLERY



CONTEMPORARY LIVING
Beige Ivory

SWIMMING POOL VILLA
Beige

DESIGN LIBRARY CAFÉ
Grey

CHARME RESORT
Desert Ivory

HOME BATHROOM
Ivory

HOTEL RESTROOM
Beige

PRODUCT
RANGE &
TECHNICAL
SPECS.



SUSTAINABILITY



THE BENEFITS OF
CERAMIC TILES



ENJOY
THE VIDEO

INDEX



OVERVIEW



IMAGE GALLERY

CONTEMPORARY LIVING
Beige IvorySWIMMING POOL VILLA
BeigeDESIGN LIBRARY CAFÉ
GreyCHARME RESORT
Desert IvoryHOME BATHROOM
IvoryHOTEL RESTROOM
BeigePRODUCT
RANGE &
TECHNICAL
SPECS.

SUSTAINABILITY

THE BENEFITS OF
CERAMIC TILESENJOY
THE VIDEO

© Ceramiche Atlas Concorde

05 THREE-DIMENSIONAL
STONE EFFECT



© Ceramiche Atlas Concorde

LIMS 3D WALLPAPER HAS A SLIGHTLY TUMBLED SURFACE WITH A REFINED DECORATIVE EFFECT. THE 3D WALL TILES ARE VERY EASY TO CLEAN.

LIMS 3D WALLPAPER HA UNA SUPERFICIE LEGGERMENTE BURATTATA DALL'EFFETTO DECORATIVO RICERCATO. IL RIVESTIMENTO 3D È FACILISSIMO DA PULIRE.

LIMS 3D WALLPAPER PRÉSENTE UNE SURFACE LÉGÈREMENT RUGUEUSE AVEC UN EFFET DÉCORATIF RAFFINÉ. LES CARREAUX 3D SONT EXTRÊMEMENT FACILES À NETTOYER.

LIMS 3D WALLPAPER HAT EINE LEICHT GETROMMELTE OBERFLÄCHE VON ANSPRECHEND DEKORATIVER WIRKUNG. DER 3D-WANDBELAG LÄSST SICH MÜHELOS REINIGEN.

LIMS 3D WALLPAPER TIENE UNA SUPERFICIE LIGERAMENTE CRIBADA CON UN REFINADO EFECTO DECORATIVO. EL RIVESTIMIENTO 3D ES MUY FÁCIL DE LIMPIAR.

ПЛИТКА LIMS 3D WALLPAPER ОБЛАДАЕТ ДЕКОРАТИВНОЙ, СЛЕГКА БУЧАРДИРОВАННОЙ ПОВЕРХНОСТЬЮ. КРАЙНЕ ПРОСТА В УХОДЕ.



FLOOR

Lims **Ivory** Tumbled
37,5x75 cm | 14³/₄" x 29¹/₂"

Lims **Exence Almond** Tatami
18,5x75 cm | 7¹/₄" x 29¹/₂"

WALL

Lims **Ivory 3D Wallpaper**
Matte/Matt
40x80 cm | 15³/₄" x 31¹/₂"



© Ceramiche Atlas Concorde

INDEX



OVERVIEW



IMAGE GALLERY



CONTEMPORARY LIVING
Beige Ivory

SWIMMING POOL VILLA
Beige

DESIGN LIBRARY CAFÉ
Grey

CHARME RESORT
Desert Ivory

HOME BATHROOM
Ivory

HOTEL RESTROOM
Beige

PRODUCT RANGE & TECHNICAL SPECS.



SUSTAINABILITY



THE BENEFITS OF CERAMIC TILES

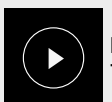

ENJOY THE VIDEO

ATLAS CONCORDE CERAMIC TILES ARE EASY TO CLEAN AND HYGIENIC BECAUSE THEY ARE NOT CONDUCTIVE TO THE PROLIFERATION OF FUNGI, MOLD AND BACTERIA. ATLAS CONCORDE CERAMIC TILES ARE IDEAL FOR COVERING THE WALLS OF BATHROOMS AND SHOWERS: THEIR EASE OF CLEANING GUARANTEES A HEALTHY ENVIRONMENT.

I RIVESTIMENTI CERAMICI ATLAS CONCORDE SONO FACILI DA PULIRE E IGIENICI PERCHÉ NON FAVORISCONO LA PROLIFERAZIONE DI FUNGHI, MUFFE E BATTERI. LA CERAMICA ATLAS CONCORDE È IDEALE PER RIVESTIRE LE PARETI DI BAGNI E DOCCE: LA FACILITÀ DI PULIZIA GARANTISCE UN AMBIENTE SALUBRE.

LES CARREAUX EN CÉRAMIQUE D'ATLAS CONCORDE SONT HYGIÉNIQUES ET FACILES À NETTOYER CAR ILS NE FAVORISENT PAS LA PROLIFÉRATION DE CHAMPIGNONS, DE MOISSISURES ET DE BACTÉRIES. LA CÉRAMIQUE D'ATLAS CONCORDE EST IDÉALE POUR HABILLER LE MUR DES SALLES DE BAINS ET DES CABINES DE DOUCHES : LA FACILITÉ DE NETTOYAGE GARANTIT LA SALUBRITÉ DE L'ESPACE.

DIE WANDFLIESEN VON ATLAS CONCORDE SIND EINFACH ZU REINIGEN UND HYGIENISCH, DA SIE DEM BEFALL VON PILZEN, SCHIMMEL UND BAKTERIEN NICHT FÖRDERLICH SIND. DIE KERAMIK VON ATLAS CONCORDE IST IDEAL FÜR DIE VERKLEIDUNG VON BÄDERN UND DUSCHEN: IHRE REINIGUNGSFREUNDLICHKEIT IST GARANTIE FÜR EINE GESUNDE UMGEBUNG.

LOS REVESTIMIENTOS CERÁMICOS ATLAS CONCORDE SON FÁCILES DE LIMPIAR E HIGIÉNICOS YA QUE NO PROMUEVEN LA PROLIFERACIÓN DE HONGOS, MOHO Y BACTERIAS. LA CERÁMICA ATLAS CONCORDE ES IDEAL PARA REVESTIR LAS PAREDES DE BAÑOS Y DUCHAS: SU FACILIDAD DE LIMPIEZA GARANTIZA UN AMBIENTE SALUDABLE.

НАСТЕННАЯ ПЛИТКА ATLAS CONCORDE ПРОСТА В УХОДЕ И ГИГИЕНИЧНА, ПОСКОЛЬКУ ПРЕПЯТСТВУЕТ РАЗМНОЖЕНИЮ ГРИБКОВ, ПЛЕСЕНИ И БАКТЕРИЙ. ИДЕАЛЬНА ДЛЯ ПОКРЫТИЯ СТЕН ВАННЫХ КОМНАТ И ДУШЕВЫХ КАБИН: ЛЕГКОСТЬ ЧИСТКИ ОБЕСПЕЧИВАЕТ ЗДОРОВУЮ СРЕДУ.



FLOOR
Lims **Ivory** Tumbled
37,5x75 cm | 14³/₄" x 29¹/₂"

Lims **Exence Almond** Tatami
18,5x75 cm | 7¹/₄" x 29¹/₂"

WALL
Lims **Ivory 3D Wallpaper**
Matte/Matt
40x80 cm | 15³/₄" x 31¹/₂"



INDEX



OVERVIEW



IMAGE GALLERY



CONTEMPORARY LIVING
Beige Ivory

SWIMMING POOL VILLA
Beige

DESIGN LIBRARY CAFÉ
Grey

CHARME RESORT
Desert Ivory

HOME BATHROOM
Ivory

HOTEL RESTROOM
Beige

PRODUCT RANGE & TECHNICAL SPECS.



SUSTAINABILITY



THE BENEFITS OF CERAMIC TILES



06 THE ELEGANCE OF LIMESTONE



CONTEMPORARY LIVING
Beige Ivory

SWIMMING POOL VILLA
Beige

DESIGN LIBRARY CAFÉ
Grey

CHARME RESORT
Desert Ivory

HOME BATHROOM
Ivory

HOTEL RESTROOM
Beige

PRODUCT RANGE & TECHNICAL SPECS.



SUSTAINABILITY



THE BENEFITS OF CERAMIC TILES



ENJOY THE VIDEO



Lims 3D Way tiles are inspired by manual stone engraving. With their characteristic herringbone pattern, they decorate the space by combining the natural appeal of stone with the guarantee of practicality of ceramic wall tiles.

Lims 3D Way è ispirato alle lavorazioni manuali di incisione delle pietre. Con la sua caratteristica trama a spina di pesce, decora l'ambiente unendo il fascino naturale della pietra alla garanzia di praticità del rivestimento ceramico.

Lims 3D Way s'inspire du façonnage manuel de la pierre. Sa trame en chevron très caractéristique décore l'espace en alliant le charme naturel de la pierre à la garantie de la praticité du revêtement céramique.

Lims 3D Way ist an manuell gravierten Natursteinen inspiriert. Mit seinem charakteristischen Fischgrätmotiv dekoriert es den Raum und vereint den natürlichen Charme des Natursteins mit der garantierten Funktionalität der keramischen Wandverkleidung.

Lims 3D Way se inspira en las elaboraciones manuales de grabado de la piedra. Con su característico dibujo en espiga, decora el ambiente combinando el encanto natural de la piedra con la practicidad garantizada del revestimiento cerámico.

Поверхность Lims 3D Way кажется выгравированной вручную. Ее елочный узор стильно декорирует интерьер, сочетая натуральный рисунок камня с практичностью керамики.



© Ceramiche Atlas Concorde

WALL
 Lims **Beige 3D Way** Matte/Matt
 40x80 cm | 15³/₄" x 31¹/₂"



© Ceramiche Atlas Concorde

INDEX



OVERVIEW



IMAGE GALLERY



CONTEMPORARY LIVING
Beige Ivory

SWIMMING POOL VILLA
Beige

DESIGN LIBRARY CAFÉ
Grey

CHARME RESORT
Desert Ivory

HOME BATHROOM
Ivory

HOTEL RESTROOM
Beige

PRODUCT
RANGE &
TECHNICAL
SPECS.



SUSTAINABILITY



THE BENEFITS OF
CERAMIC TILES

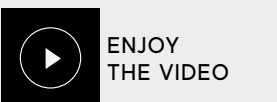



© Ceramiche Atlas Concorde



© Ceramiche Atlas Concorde

FLOOR
 Lims **Beige** Matte/Matt
 37,5x75 cm | 14³/₄" x 29¹/₂"

WALL
 Lims **Beige** Matte/Matt
 40x80 cm | 15³/₄" x 31¹/₂"

Lims **Beige** Mosaico Tumbled
 30x30 cm | 11³/₄" x 11³/₄"



INDEX



OVERVIEW



IMAGE GALLERY



CONTEMPORARY LIVING
Beige Ivory

SWIMMING POOL VILLA
Beige

DESIGN LIBRARY CAFÉ
Grey

CHARME RESORT
Desert Ivory

HOME BATHROOM
Ivory

HOTEL RESTROOM
Beige

PRODUCT RANGE & TECHNICAL SPECS.



SUSTAINABILITY



THE BENEFITS OF CERAMIC TILES



ENJOY THE VIDEO



© Ceramiche Atlas Concorde

THE PORCELAIN MOSAICO TUMBLED FEATURES SQUARE TILES WITH THE TUMBLED EDGES CHARACTERISTIC OF NATURAL STONWORK.

IL MOSAICO TUMBLED, IN GRES PORCELLANATO, PRESENTA TESSERE QUADRATE DAI BORDI BURATTATI, CARATTERISTICI DELLA LAVORAZIONE DELLE PIETRE NATURALI.

LE DÉCOR MOSAICO TUMBLED, EN GRÈS CÉRAMÉ, PRÉSENTE DES TESSELLES CARRÉES AUX BORDS IRRÉGULIERS, CARACTÉRISTIQUES DU FAÇONNAGE DES PIERRES NATURELLES.

DAS MOSAICO TUMBLED AUS FEINSTEINZEUGS BESTEHT AUS QUADRATISCHEN MOSAIKSTEINCHEN MIT DEN FÜR BEARBEITETEN NATURSTEIN CHARAKTERISTISCHEN, GETROMMELTEN KANTEN.

EL MOSAICO TUMBLED, EN GRES PORCELÁNICO, PRESENTA TESELAS CUADRADAS CON BORDES CRIBADOS, CARACTERÍSTICOS DE LA ELABORACIÓN DE LAS PIEDRAS NATURALES.

КЕРАМОГРАНИТНАЯ МОЗАИКА TUMBLED ИМЕЕТ ОБТОЧЕННЫЕ, КАК У ОБРАБОТАННОГО ПРИРОДНОГО КАМНЯ, КРАЯ.

FLOOR | WALL

Lims **Beige** Mosaico Tumbled
30x30 cm | 11³/₄" x 11³/₄"



IN THE MOSAICO SPRITZ, THE SMALL RECTANGLES WITH IRREGULAR EDGES TYPICAL OF SPLIT STONE CREATE AN EFFECT THAT IS BOTH NATURAL AND ELEGANT.

NEL MOSAICO SPRITZ, I PICCOLI RETTANGOLI DAI BORDI IRREGOLARI, TIPICI DELLE LAVORAZIONI A SPACCO, CREANO UN EFFETTO NATURALE ED ELEGANTE AL TEMPO STESSO.

DANS LE DÉCOR MOSAICO SPRITZ, DE PETITS RECTANGLES AUX FORMES ET AUX BORDS IRRÉGULIERS, TYPIQUES DU FAÇONNAGE À L'ANCIENNE, CRÉENT UN EFFET À LA FOIS NATUREL ET ÉLÉGANTE.

IM MOSAICO SPRITZ ERZEUGEN KLEINE RECHTECKE MIT UNREGELMÄSSIGEN KANTEN, WIE SIE DURCH DAS SPALTEN DER STEINE ENTSTEHEN, EINE NATÜRLICHE UND ZUGLEICH ELEGANTE WIRKUNG.

EN MOSAICO SPRITZ, LAS TESELAS DE SUPERFICIE NATURAL SE MEZCLAN ALEATORIAMENTE CON OTRAS DE SUPERFICIE ABUJARDADA, CREANDO UN EFECTO DE DINAMISMO Y NATURALIDAD.

В МОЗАИКЕ SPRITZ ПЕРЕМЕШАННЫЕ ЭЛЕМЕНТЫ С НАТУРАЛЬНОЙ И БУЧАРДИРОВАННОЙ ПОВЕРХНОСТЬЮ СОЗДАЮТ ИНТЕРЕСНЫЙ ЭФФЕКТ ДИНАМИЗМА.

WALL

Lims **Beige** Mosaico Spritz
29x32,3 cm - 11³/₈" x 12³/₄"



© Ceramiche Atlas Concorde



© Ceramiche Atlas Concorde

INDEX



OVERVIEW



IMAGE GALLERY



CONTEMPORARY LIVING
Beige Ivory

SWIMMING POOL VILLA
Beige

DESIGN LIBRARY CAFÉ
Grey

CHARME RESORT
Desert Ivory

HOME BATHROOM
Ivory

HOTEL RESTROOM
Beige

PRODUCT
RANGE &
TECHNICAL
SPECS.



SUSTAINABILITY



THE BENEFITS OF
CERAMIC TILES



ENJOY
THE VIDEO



© Ceramiche Atlas Concorde

Product Range & Technical Specifications

- 80 PRODUCT RANGE
- 86 TRIM TILES
- 88 TECHNICAL SPECIFICATIONS

INDEX



OVERVIEW



IMAGE GALLERY



PRODUCT RANGE & TECHNICAL SPECS.



RANGE SUMMARY

TRIM TILES

TECHNICAL FEATURES

SUSTAINABILITY



THE BENEFITS OF CERAMIC TILES



ENJOY THE VIDEO

LIMS

Porcelain tiles

COLOURED BODY PORCELAIN TILES - RECTIFIED MONOCALIBER

GRES PORCELLANATO COLORATO IN MASSA - RETTIFICATO MONOCALIBRO

Grès cérame coloré dans la masse - Rectifié mono-calibre / Durchgefärbtes Feinsteinzeug - Geschliffen einkalbrig /

Gres porcelánico coloreado en masa - Rectificado monocalibre / Керамический гранит окрашенный в массе - Ретифицированный в одном калибре

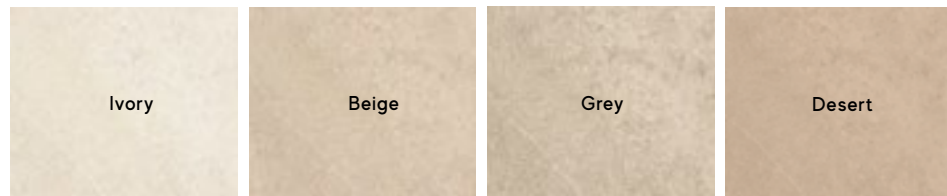

| | | | | | |
|--|--------|--------------------------|--------------------------|--------------------------|--------------------------|
| 120x278 cm - 47 ¹ / ₄ "x109 ¹ / ₂ " | ± 6 mm | Matte | Matte | Matte | Matte |
| 120x120 cm - 47 ¹ / ₄ "x47 ¹ / ₄ " | ± 9 mm | Matte | Matte | Matte | Matte |
| 75x150 cm - 29 ¹ / ₂ "x59" | ± 9 mm | Matte | Matte | Matte | Matte |
| 75x75 cm - 29 ¹ / ₂ "x29 ¹ / ₂ " | ± 9 mm | Matte | Matte | Matte | Matte |
| 37,5x75 cm - 14 ³ / ₄ "x29 ¹ / ₂ " | ± 9 mm | Matte Bush Hammered Line | Matte Bush Hammered Line | Matte Bush Hammered Line | Matte Bush Hammered Line |
| 37,5x75 cm - 14 ³ / ₄ "x29 ¹ / ₂ " Tumbled | ± 9 mm | Matte | Matte | Matte | Matte |



Outdoor and Wet Areas

| | | | | | |
|--|---------|---------|---------|---------|---------|
| 37,5x75 cm - 14 ³ / ₄ "x29 ¹ / ₂ " | ± 9 mm | Grip | Grip | Grip | Grip |
| 60x120 cm - 23 ⁵ / ₈ "x47 ¹ / ₄ " | ± 20 mm | Outdoor | Outdoor | Outdoor | Outdoor |
| 60x60 cm - 23 ⁵ / ₈ "x23 ⁵ / ₈ " | ± 20 mm | Outdoor | Outdoor | Outdoor | Outdoor |

Destination of use



Anti-slip

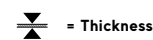
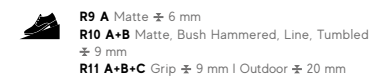

= Thickness

Color-shading



V3 Moderate Variation



IVORY

GREY



BEIGE

DESERT

INDEX



OVERVIEW



IMAGE GALLERY



PRODUCT RANGE & TECHNICAL SPECS.



RANGE SUMMARY

TRIM TILES

TECHNICAL FEATURES

SUSTAINABILITY



THE BENEFITS OF CERAMIC TILES



LIMS
Porcelain tiles

Lims Bush Hammered
>Available in all colors
37,5x75 cm - 14³/₄"x29¹/₂"



© Ceramiche Atlas Concorde

Lims Line
>Available in all colors
37,5x75 cm - 14³/₄"x29¹/₂"



© Ceramiche Atlas Concorde

Lims Tumbled
>Available in all colors
37,5x75 cm - 14³/₄"x29¹/₂"



© Ceramiche Atlas Concorde

LIMS
Porcelain tile decors

Lims Ivory Brick
37,5x75 cm - 14³/₄"x29¹/₂"



Lims Beige Brick
37,5x75 cm - 14³/₄"x29¹/₂"



Lims Grey Brick
37,5x75 cm - 14³/₄"x29¹/₂"



Lims Desert Brick
37,5x75 cm - 14³/₄"x29¹/₂"



Lims Ivory Mosaico Gemini
41,6x24 cm - 12¹/₄"x9¹/₂"



Lims Beige Mosaico Gemini
41,6x24 cm - 12¹/₄"x9¹/₂"



Lims Grey Mosaico Gemini
41,6x24 cm - 12¹/₄"x9¹/₂"



Lims Desert Mosaico Gemini
41,6x24 cm - 12¹/₄"x9¹/₂"



Range Summary

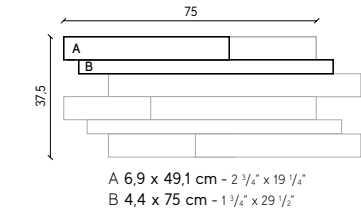

Lims Ivory Mosaico Spritz
29x32,3 cm - 11³/₈"x12³/₄"



Lims Beige Mosaico Spritz
29x32,3 cm - 11³/₈"x12³/₄"



Lims Grey Mosaico Spritz
29x32,3 cm - 11³/₈"x12³/₄"



Lims Desert Mosaico Spritz
29x32,3 cm - 11³/₈"x12³/₄"

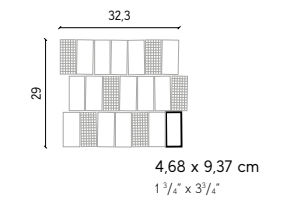
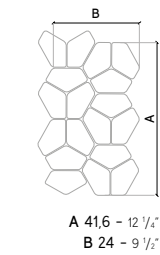

Lims Ivory Mosaico Tumbled
30x30 cm - 11³/₄"x11³/₄"



Lims Beige Mosaico Tumbled
30x30 cm - 11³/₄"x11³/₄"



Lims Grey Mosaico Tumbled
30x30 cm - 11³/₄"x11³/₄"



Lims Desert Mosaico Tumbled
30x30 cm - 11³/₄"x11³/₄"



INDEX



OVERVIEW



IMAGE GALLERY



PRODUCT RANGE & TECHNICAL SPECS.



RANGE SUMMARY

TRIM TILES

TECHNICAL FEATURES

SUSTAINABILITY



THE BENEFITS OF CERAMIC TILES



LIMS

Wall tiles

WHITEBODY WALL TILES - RECTIFIED MONOCALIBER

RIVESTIMENTI IN PASTA BIANCA - RETTIFICATO MONOCALIBRO

Revêtements en pâte blanche - Rectifié mono-calibre / Weißscherbige Wandfliesen - Geschliffen einkalibrig

Revestimientos en pasta blanca - Rectificado monocolor / Настенная плитка из белой глины - Ретицированный в одном калибре

| Sizes | Thickness | Surface finish | Available colors |
|--|-------------------|----------------|------------------|
| 40x80 cm - 15 ³ / ₄ "x31 ¹ / ₂ " | ± 8,5 mm | Matte | > Ivory, Beige |
| 40x80 cm - 15 ³ / ₄ "x31 ¹ / ₂ " | ± 10 mm 3D | Matte | > Ivory, Beige |

Lims Ivory

40x80 cm - 15³/₄"x31¹/₂"

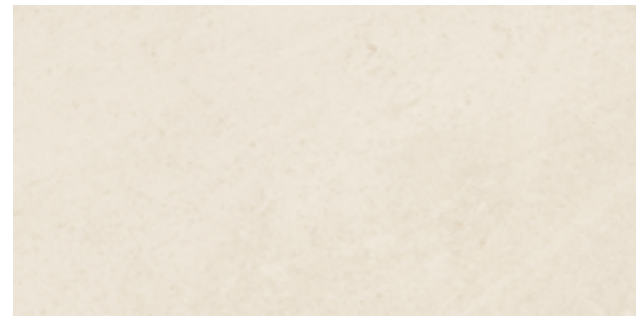

Lims Beige

40x80 cm - 15³/₄"x31¹/₂"

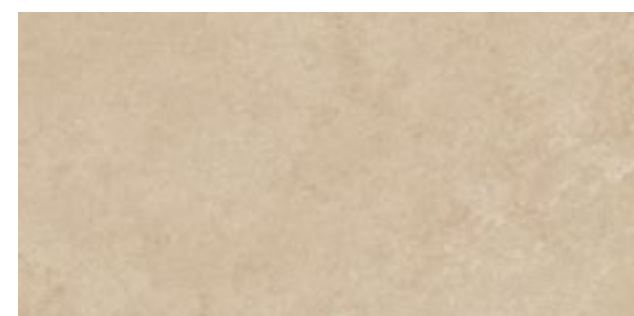

Lims 3D Wallpaper Ivory

40x80 cm - 15³/₄"x31¹/₂"



Lims 3D Wallpaper Beige

40x80 cm - 15³/₄"x31¹/₂"

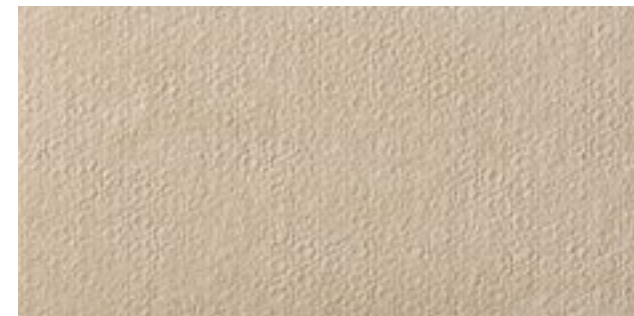

Lims 3D Way Ivory

40x80 cm - 15³/₄"x31¹/₂"

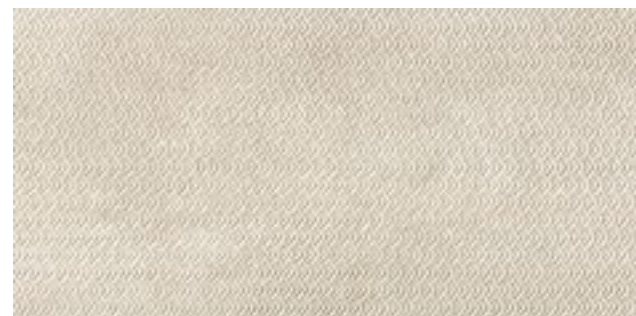

Lims 3D Way Beige

40x80 cm - 15³/₄"x31¹/₂"

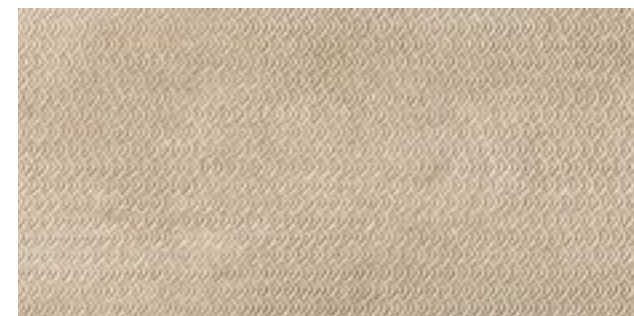

Color-shading
V2 Slight Variation > Ivory, Beige



© Ceramiche Atlas Concorde

INDEX



OVERVIEW



IMAGE GALLERY



PRODUCT RANGE & TECHNICAL SPECS.



RANGE SUMMARY

TRIM TILES

TECHNICAL FEATURES

SUSTAINABILITY



THE BENEFITS OF CERAMIC TILES



ENJOY THE VIDEO

LIMS

Trim tiles

INDOOR TRIM TILES

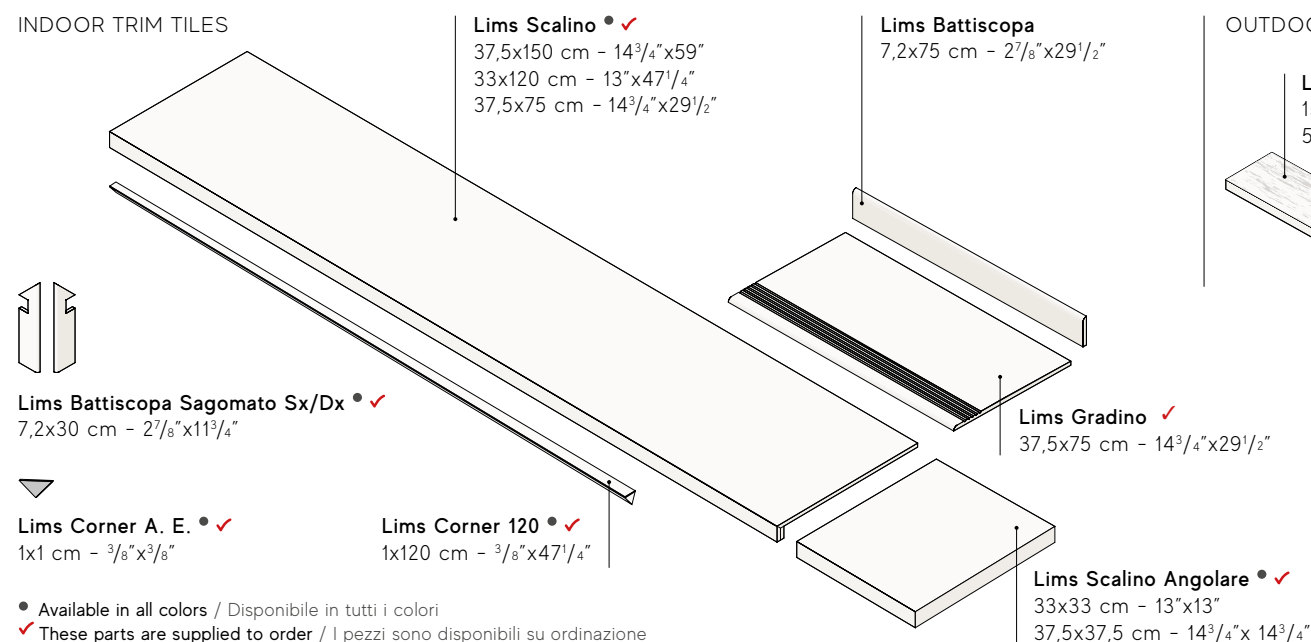

OUTDOOR TRIM TILES

Lims Elemento L Grip ✓
15x75 H.4 cm
5⁷/₈"x29¹/₂" H. 1⁵/₈"

Outdoor trim tiles ± 20 mm

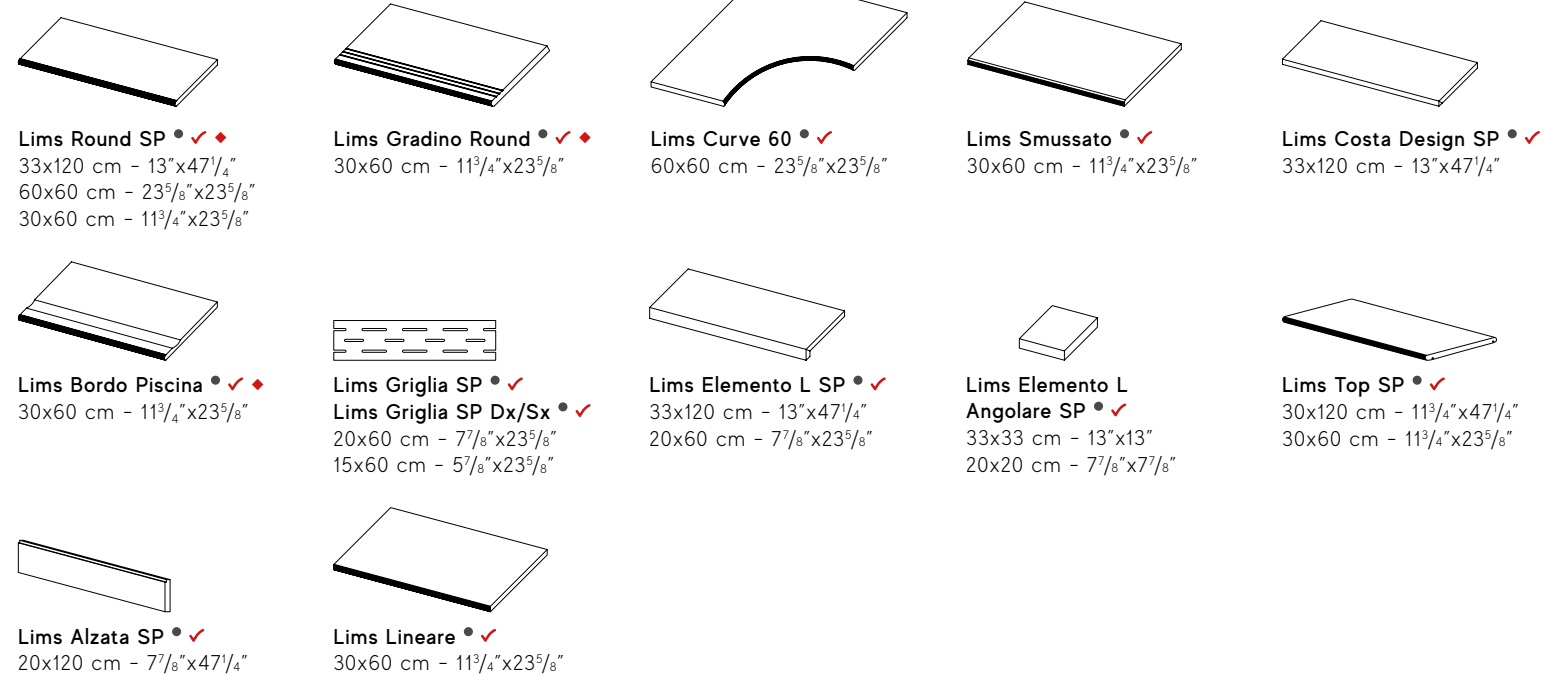

Wall trim tiles

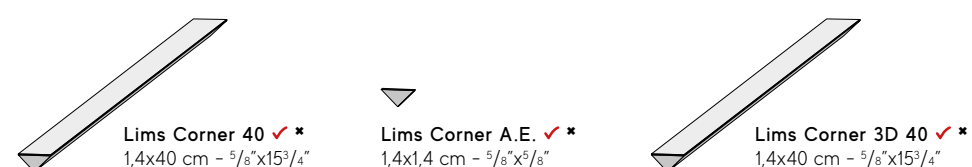

- Available in all colors / Disponibile in tutti i colori
- * Available in / Disponibile in Ivory, Beige
- ✓ These parts are supplied to order / I pezzi sono disponibili su ordinazione
- ♦ Right-left angular elements are available / Sono disponibili gli elementi angolari dx/sx



Note

For information and details relating to codes, packaging and weight it is recommended to refer to the latest pricelist. / Per le informazioni e i dati relativi a codici, imballaggi e pesi occorre sempre consultare l'ultimo listino aggiornato e in vigore. / Pour toutes informations et renseignements concernant les codes, les emballages et les poids, il y a toujours lieu de consulter le dernier tarif en vigueur et mis à jour. / Für Informationen und Daten die den Code, die Verpackung und das Gewicht betreffen bitte die aktuellste Preisliste zugrunde legen. / Para acceder a la información y a los datos relativos a códigos, embalajes y pesos hay que consultar siempre la última lista de precios actualizada y vigente. / Для информации о кодах, упаковках и весе обращайтесь к последнему действующему прайс-листу.

Colors and optical features of the materials illustrated in this catalogue are to be regarded as mere indications. / I colori e le caratteristiche estetiche dei materiali illustrati nel presente catalogo sono da ritenersi puramente indicativi. / Les coloris et les caractéristiques esthétiques des références illustrées dans le catalogue sont donnés à titre purement indicatif. / Die Farben und die ästhetischen Eigenschaften der in diesem Katalog abgebildeten Produkte sind als reine Richtwerte zu betrachten. / Los colores y las características estéticas de los materiales ilustrados en el presente catálogo deben ser considerados como puramente indicativos. / Цвета и эстетические характеристики описанных в настоящем каталоге материалов являются только ориентировочными.

Atlas Concorde reserves the right to modify any product without notice and will not be liable for any direct or indirect damage resulting from such modifications. / Atlas Concorde si riserva di modificare i prodotti senza preavviso, declinando ogni responsabilità su eventuali danni diretti o indiretti derivanti da eventuali modifiche. / Atlas Concorde se réserve le droit de modifier ses produits sans préavis et décline toute responsabilité concernant les éventuels dommages directs ou indirects qui pourraient dériver de ces modifications. / Atlas Concorde behält sich das Recht vor jederzeit und ohne vorherige Ankündigung, die Produkte zu verändern, und lehnt jede Haftung bei direkten oder indirekten Schäden ab, die von diesen Veränderungen herrühren. / Atlas Concorde se reserva el derecho de modificar los productos sin previo aviso, rechaza cualquier responsabilidad sobre eventuales daños directos o indirectos derivados de eventuales modificaciones. / Atlas Concorde оставляет за собой право изменять характеристики изделий без предварительного уведомления, отклоняя при этом любую ответственность за прямые или косвенные убытки, возникшие в результате изменений.

THANKS TO

Artemide
www.artemide.com

bross
www.bross-italy.com

CASAMANIA
www.horm.it

THE MALE TOOLS & Co.
DEPOT
ORIGINAL FORMULAS
www.depotmaletools.com

Enrico Sironi
www.sironienrico.it

Frag
www.frag.it

HORM
www.horm.it

laFABBRICAdeLLINO
www.lafabbricadelino.com

L
www.laesseceramica.it

Oliver B.
www.oliverb.it

Opificio
www.torino.it
www.lopificio.it

Tognana
www.tognana.com

VILLA COLLECTION
DENMARK
www.villacollectiondenmark.com

ZEVA
www.zeusnoto.com

ZUCCHI
www.zucchi.it

INDEX



OVERVIEW



IMAGE GALLERY



PRODUCT RANGE & TECHNICAL SPECS.



RANGE SUMMARY

TRIM TILES

TECHNICAL FEATURES

SUSTAINABILITY



THE BENEFITS OF CERAMIC TILES



ENJOY THE VIDEO





White body wall tiles - Rectified monocaliber

Rivestimenti in pasta bianca - Rettificato monocalibro

Compliant with standards EN 14411 annex L group BIII
 Compliant with standards ISO 13006 annex L group BIII
 Conforme alla norma EN 14411 Appendice L gruppo BIII
 Conforme alla norma ISO 13006 Appendice L gruppo BIII

40x80 cm - 15 7/8" x 31 1/2"
 40x80 cm - 15 7/8" x 31 1/2"
 ± 8,5 mm
 ± 10 mm 3D

| Technical features Caratteristiche tecniche | | Requirements for nominal size N Requisiti per dimensione nominale N | | | Wall tiles | | | |
|--|--|--|--|--|--|--|--|---|
| | | 7 cm ≤ N < 15 cm (mm) | N ≥ 15 cm (%) (mm) | | | | | |
| | Length and width Lunghezza e larghezza | ± 0,4 (*) Rect. | ± 0,3 (*) Rect. | ± 1,0 (*) Rect. | Suitable for Conforme | | | |
| | Thickness Spessore | ± 0,5 (**) | ± 10 (**) | ± 0,5 (**) | | Suitable for Conforme | | |
| | Straightness of sides Rettilineità degli spigoli | ± 0,4 (***) Rect. | ± 0,3 (***) Rect. | ± 0,8 (***) Rect. | | | | |
| | Rectangularity Ortogonalità | ISO 10545-2 | ± 0,4 (****) Rect. | ± 0,3 (****) Rect. | ± 1,5 (****) Rect. | Suitable for Conforme | | |
| | | Surface flatness Planarità | c.c. ± 0,6 Rect. | c.c. ± 0,4 Rect. | c.c. ± 1,8 Rect. | Suitable for Conforme | | |
| | | | e.c. ± 0,6 Rect. | e.c. ± 0,4 Rect. | e.c. ± 1,8 Rect. | | | |
| | Water absorption (in % by mass) Massa d'acqua assorbita (come % della massa) | ISO 10545-3 | Average >10%. When the average > 20%, this shall be indicated. Individual value > 9%. Media >10%. Se questo valore > 20%, deve essere indicato. Valore Singolo > 9% | | | 10% < E _v ≤ 20 % | | |
| | | | | Breaking strength Sforzo di rottura | S ≥ 600 N | | S ≥ 600 N | |
| | | | | | | | | Modulus of rupture Resistenza alla flessione |
| | Coefficient of thermal linear expansion Coefficiente di dilatazione termica lineare | ISO 10545-8 | Declared value Valore dichiarato | | | ≤ 7 MK ⁻¹ | | |
| | | | | Thermal shock resistance Resistenza agli sbalzi termici | ISO 10545-9 | | Pass according to ISO 10545-1 Test superato in accordo con ISO 10545-1 | |
| | Moisture expansion (in mm/m) Dilatazione all'umidità (in mm/m) | ISO 10545-10 | | | | Declared value Valore dichiarato | | ≤ 0,06% (0,6mm/m) |
| | | | | Cracking resistance Resistenza al cavillo | ISO 10545-11 | Pass according to EN ISO 10545-1 Test superato in accordo con ISO 10545-1 | | |
| | Bond strength/adhesion for improved cementitious adhesives Adesione a trazione con adesivi cementizi migliorati | EN 1348 | | | | Declared value Valore dichiarato | | ≥ 10 N/mm ² (Class C2 - EN 12004) |
| | | | | Reaction to fire Reazione al fuoco | - | Class A1 Classe A1 | | |
| | Resistance to household chemicals and swimming pool salts Resistenza ai prodotti chimici di uso domestico ed agli additivi per piscina | ISO 10545-13 | | | | Minimum Class B Classe minima B | | A |
| | | | | Resistance to low concentrations of acids and alkalis Resistenza a basse concentrazioni di acidi e alcali | Declared Class Classe dichiarata | | LA | |
| | | | | | | Resistance to high concentrations of acids and alkalis Resistenza ad alte concentrazioni di acidi e alcali | | |
| | Resistance to staining Resistenza alle macchie | ISO 10545-14 | Minimum Class 3 Classe 3 minima | | | | 5 | |
| | | | | Release of dangerous substances: Cadmium (in mg/dm²) and Lead (in mg/dm²) Rilascio di sostanze pericolose: Cadmio (in mg/dm ²) e Piombo (in mg/dm ²) | ISO 10545-15 | Declared value Valore dichiarato | | ≤ 0,01 mg/dm ² Cd ≤ 0,1 mg/dm ² Pb |



Coloured body porcelain tiles - Rectified monocaliber

Gres porcellanato colorato in massa - Rettificato monocalibro

Compliant with standards EN 14411 annex G group BII
 Compliant with standards ISO 13006 annex G group BII
 Conforme alla norma EN 14411 Appendice G gruppo BII
 Conforme alla norma ISO 13006 Appendice G gruppo BII

120x120 cm - 47 1/8" x 47 1/8"
 75x150 cm - 29 1/2" x 59"
 75x75 cm - 29 1/2" x 29 1/2"
 37,5x75 cm - 14 7/8" x 29 1/2"

± 9 mm
 ± 9 mm
 ± 9 mm
 ± 9 mm
 120x278 cm - 47 1/8" x 109 1/4"
 60x120 cm - 23 5/8" x 47 1/4"
 60x60 cm - 23 5/8" x 23 5/8"
 ± 6 mm
 ± 20 mm
 ± 20 mm

| Technical features Caratteristiche tecniche | Test Method Metodo di prova | Requirements for nominal size N Requisiti per dimensione nominale N | | | Porcelain tiles | | | | | | | | | | |
|--|--|--|--|---|--|---|--|---------------------------------|---|---|---|---|---------------------------------|---------------------------------|---|
| | | 7 cm ≤ N < 15 cm (mm) | N ≥ 15 cm (%) (mm) | | Matte ± 9 mm | Matte ± 6 mm | Grip ± 9 mm | Outdoor ± 20 mm | | | | | | | |
| | Length and width Lunghezza e larghezza | ± 0,9 (*) Non-rect. ± 0,4 (*) Rect. | ± 0,6 (*) Non-rect. ± 0,3 (*) Rect. | ± 2,0 (*) Non-rect. ± 1,0 (*) Rect. | Suitable for Conforme | Suitable for Conforme | Suitable for Conforme | Suitable for Conforme | | | | | | | |
| | | Thickness Spessore | ± 0,5 (**) | ± 5 (**) | | | | | ± 0,5 (**) | | | | | | |
| | | Straightness of sides Rettilineità degli spigoli | ± 0,8 (***) Non-rect. ± 0,4 (***) Rect. | ± 0,5 (***) Non-rect. ± 0,3 (***) Rect. | | | | | ± 1,5 (***) Non-rect. ± 0,8 (***) Rect. | | | | | | |
| | Rectangularity (Measurement only on short edges when L/l ≥ 3) Ortogonalità (Misurazione da condurre solo sui lati corti quando L/l ≥ 3) | ± 0,8 (****) Non-rect. ± 0,4 (****) Rect. | ± 0,5 (****) Non-rect. ± 0,3 (****) Rect. | ± 2,0 (****) Non-rect. ± 1,5 (****) Rect. | Suitable for Conforme | Suitable for Conforme | Suitable for Conforme | Suitable for Conforme | | | | | | | |
| | | | Surface flatness Planarità | ISO 10545-2 | | | | | c.c. ± 0,8 Non-rect. c.c. ± 0,6 Rect. | c.c. ± 0,5 Non-rect. c.c. ± 0,4 Rect. | c.c. ± 2,0 Non-rect. c.c. ± 1,8 Rect. | Suitable for Conforme | Suitable for Conforme | Suitable for Conforme | Not applicable to strong structures Non applicabile a strutture forti |
| | | | | | | | | | e.c. ± 0,8 Non-rect. e.c. ± 0,6 Rect. | e.c. ± 0,5 Non-rect. e.c. ± 0,4 Rect. | e.c. ± 2,0 Non-rect. e.c. ± 1,8 Rect. | | | | |
| | Water absorption (in % by mass) Massa d'acqua assorbita | ISO 10545-3 | E_v ≤ 0,5% Individual Maximum 0,6% E _v ≤ 0,5% Valore massimo singolo 0,6% | | | ≤ 0,1% | ≤ 0,1% | ≤ 0,1% | ≤ 0,1% | | | | | | |
| | | | ASTM C373-18 | Requirement ANSI A137.1-2017 Water absorption max ≤ 0,5% | | | | | | ≤ 0,5% | ≤ 0,5% | ≤ 0,5% | ≤ 0,5% | | |
| | Breaking strength Sforzo di rottura | ISO 10545-4 | | S ≥ 700N (for thickness < 7,5 mm - per spessore < 7,5 mm) S ≥ 1300N (for thickness ≥ 7,5 mm - per spessore ≥ 7,5 mm) | | | S ≥ 1500 N | S ≥ 1000 N | S ≥ 1500 N | S ≥ 10000 N | | | | | |
| | | | | Modulus of rupture Resistenza alla flessione | R ≥ 35 N/mm ² | | | R ≥ 40 N/mm ² | R ≥ 40 N/mm ² | R ≥ 40 N/mm ² | R ≥ 45 N/mm ² | | | | |
| | Bending strength and breaking load Resistenza a flessione e al carico di rottura (4)(5) | EN 1339 Annex F | | | - | | | - | - | - | ≥T11 60x60 | ≥U4 60x120 | | | |
| | | | | Impact resistance, as coefficient of restitution Resistenza all'impatto, espresso come coefficiente di restituzione | ISO 10545-5 | Declared value Valore dichiarato | | | ≥ 0,55 | ≥ 0,55 | ≥ 0,55 | ≥ 0,55 | | | |
| | Mohs hardness Durezza Mohs | EN 101 | | | | - | | | 6 | 6 | 7 | 8 | | | |
| | | | | Resistance to deep abrasion of unglazed tiles (removed volume) Resistenza all'abrasione profonda delle piastrelle non smaltate (volume materiale asportato) | ISO 10545-6 | ≤ 175 mm ³ | | | ≤ 150 mm ³ | ≤ 150 mm ³ | ≤ 150 mm ³ | ≤ 150 mm ³ | | | |
| | Coefficient of thermal linear expansion Coefficiente di dilatazione termica lineare | ISO 10545-8 | | | | Declared value Valore dichiarato | | | ≤ 7 MK ⁻¹ | ≤ 7 MK ⁻¹ | ≤ 7 MK ⁻¹ | ≤ 7 MK ⁻¹ | | | |
| | | | | Thermal shock resistance Resistenza agli sbalzi termici | ISO 10545-9 | Pass according to EN ISO 10545-1 Test superato in accordo con ISO 10545-1 | | | Resistant Resiste | Resistant Resiste | Resistant Resiste | Resistant Resiste | | | |
| | Moisture expansion (in mm/m) Dilatazione all'umidità (in mm/m) | ISO 10545-10 | | | | Declared value Valore dichiarato | | | ≤ 0,01% (0,1mm/m) | ≤ 0,01% (0,1mm/m) | ≤ 0,01% (0,1mm/m) | ≤ 0,01% (0,1mm/m) | | | |
| | | | | Frost resistance Resistenza al gelo | ISO 10545-12 | Pass according to EN ISO 10545-1 Test superato in accordo con ISO 10545-1 | | | Resistant Resiste | Resistant Resiste | Resistant Resiste | Resistant Resiste | | | |
| | Bond strength/adhesion for improved cementitious adhesives Adesione a trazione con adesivi cementizi migliorati | EN 1348 | | | | Declared value Valore dichiarato | | | ≥ 10 N/mm ² (Class C2 - EN 12004) | ≥ 10 N/mm ² (Class C2 - EN 12004) | ≥ 10 N/mm ² (Class C2 - EN 12004) | ≥ 10 N/mm ² (Class C2 - EN 12004) | | | |
| | | | | Reaction to fire Reazione al fuoco | - | Class A1 or A1_f Classe A1 oppure A1 _f | | | A1 - A1 _f | A1 - A1 _f | A1 - A1 _f | A1 - A1 _f | | | |
| | Resistance to household chemicals and swimming pool salts Resistenza ai prodotti chimici di uso domestico e agli additivi per piscina | ISO 10545-13 | | | | Minimum Class B Classe minima B | | | A | A | A | A | | | |
| | | | | Resistance to low concentrations of acids and alkalis Resistenza a basse concentrazioni di acidi e alcali | Declared Class Classe dichiarata | | | LA | LA | LA | LA | | | | |
| | | | | | | Resistance to high concentrations of acids and alkalis Resistenza ad alte concentrazioni di acidi e alcali | Declared Class Classe dichiarata | | | HA | HA | HA | HA | | |
| | Resistance to staining Resistenza alle macchie | ISO 10545-14 | Minimum Class 3 Classe 3 minima | | | | 5 | 5 | 5 | 5 | | | | | |
| | | | | Shod Ramp Test Metodo della rampa calzato | DIN 51130 | Declared value Valore dichiarato | | | R10 | R9 | R11 | R11 | | | |
| | Barefoot Ramp Test Metodo della rampa a piedi nudi | DIN 51097 | | | | Declared value Valore dichiarato | | | A+B | A | A+B+C | A+B+C | | | |
| | | | | Pendulum Friction Test Metodo del Pendolo | AS 4586 | PTV ≥ 36 classifies the surface as 'low slip risk' | | | ≥ 36 Dry ≥ 36 Wet | (●) | ≥ 36 Dry ≥ 36 Wet | ≥ 36 Dry ≥ 36 Wet | | | |
| | Coefficient of friction (COF) Coefficiente di attrito | UNE-ENV 12633 - UNE 41901:2017 EX | | | | Declared value Valore dichiarato | | | Class P3 | (●●) | Class P4 | ≥ Class P4 | | | |
| | | | | Dynamic coefficient of friction (DCOF) Coefficiente di attrito dinamico | ANSI A137.1 | ANSI A.137.1-2017 Requires a minimum value of 0,42 for level interior space expected to be walked upon when wet. (3) | | | Class C2 | (●●●) | Class C3 | Class C3 | | | |
| | Release of dangerous substances: Cadmium (in mg/dm²) and Lead (in mg/dm²) Rilascio di sostanze pericolose: Cadmio (in mg/dm ²) e Piombo (in mg/dm ²) | B.C.R.A. Rep. CEC/81 | | | | D. M. 236/89 del 14/06/89 μ > 0,40 per elemento scivolante cuoio su pavimentazione asciutta μ > 0,40 per elemento scivolante gomma dura su pavimentazione bagnata | | | > 0,40 Asciutto > 0,40 Bagnato | > 0,40 Asciutto > 0,40 Bagnato | > 0,40 Asciutto > 0,40 Bagnato | > 0,40 Asciutto > 0,40 Bagnato | | | |

(*) The permissible deviation, in % or mm, of the average size for each tile (2 or 4 sides) from work size (WS).
 Deviazione ammissibile, in % oppure mm, della dimensione media di ogni piastrella (2 oppure 4 lati) dalla dimensione di fabbricazione (WS).
 (***) The permissible deviation, in % or mm, of the average thickness for each tile from the work size thickness (WS).
 Deviazione ammissibile, in % oppure mm, dello spessore medio di ogni piastrella dallo spessore riportato nella dimensione di fabbricazione (WS).
 (****) The maximum permissible deviation from straightness, in % or mm, related to the corresponding work sizes (WS).
 Deviazione massima ammissibile di rettilineità, in % oppure mm, in rapporto alle dimensioni di fabbricazione (WS) corrispondenti.
 (*****) The maximum permissible deviation from rectangularity, in % or mm, related to the corresponding work sizes (WS).
 Deviazione massima ammissibile di ortogonalità, in % oppure mm, in rapporto alle dimensioni di fabbricazione (WS) corrispondenti.

(*) The permissible deviation, in % or mm, of the average size for each tile (2 or 4 sides) from work size (WS).
 Deviazione ammissibile, in % oppure mm, della dimensione media di ogni piastrella (2 oppure 4 lati) dalla dimensione di fabbricazione (WS).
 (****) The maximum permissible deviation from straightness, in % or mm, related to the corresponding work sizes (WS).
 Deviazione massima ammissibile di rettilineità, in % oppure mm, in rapporto alle dimensioni di fabbricazione (WS) corrispondenti.
 (*****) The maximum permissible deviation from rectangularity, in % or mm, related to the corresponding work sizes (WS).
 Deviazione massima ammissibile di ortogonalità, in % oppure mm, in rapporto alle dimensioni di fabbricazione (WS) corrispondenti.
 (1) Determination of slip resistance of pedestrian surfaces; it does not cover sports surfaces and road surfaces for vehicles (skid resistance).
 (2) Anti-slip performance is guaranteed at the time of delivery of the product.

(3) However, tiles with a DCOF of 0,42 or greater are not necessarily suitable for all projects. The specifier shall determine tiles appropriate for specific project conditions, considering by way of example, but not in limitation, type of use, traffic, expected contaminants, expected maintenance, expected wear, and manufacturers' guidelines and recommendations.
 (4) For further details, please refer to outdoor design general catalogue.
 (5) Only for products with 20 mm thickness.
 (6) PTV ≥ 36 Wet on demand
 (●●) P3 on demand
 (●●●) C2 on demand

INDEX

OVERVIEW

IMAGE GALLERY

PRODUCT RANGE & TECHNICAL SPECS.

RANGE SUMMARY

TRIM TILES

TECHNICAL FEATURES

SUSTAINABILITY

THE BENEFITS OF CERAMIC TILES



Environmental sustainability

 DISCOVER MORE
EN | IT | FR | DE | ES | RU

Our certifications:



Energy efficiency

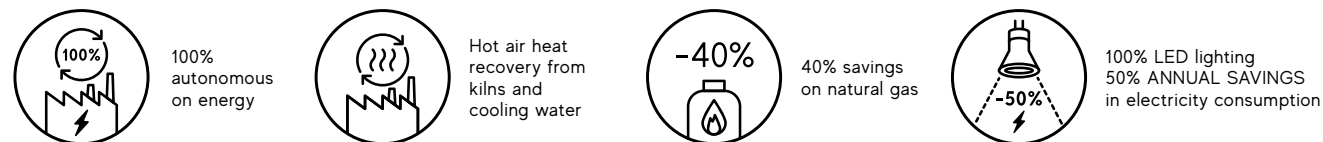

Waste management

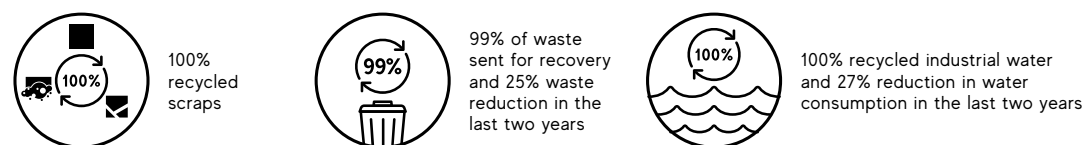

Environment and health first

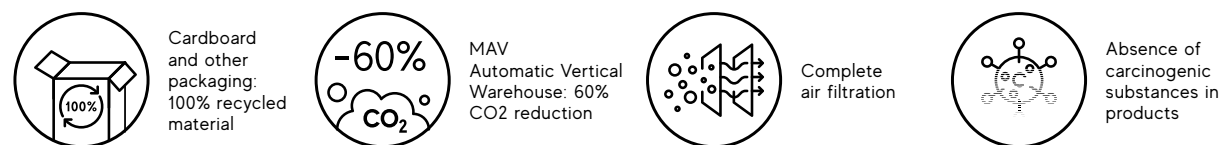

An ecological transition is among the company's industrial priorities. Our plants comply with the most stringent international regulations – fully automated and low-impact – as they are equipped with energy cogeneration systems. A constant commitment to the total reduction of waste and emissions completes the picture of a company oriented towards maximum environmental sustainability.

La transition écologique est une des priorités industrielles de l'entreprise. Nos installations sont conformes aux réglementations internationales les plus sévères, entièrement automatisées et à faible impact, car équipées de systèmes de cogénération énergétique. L'engagement constant pour la réduction totale du gaspillage et des émissions complète le tableau d'une entreprise engagée pour une meilleure durabilité environnementale.

La transición ecológica está entre las prioridades industriales de la empresa. Nuestras plantas cumplen las normas internacionales más estrictas, totalmente automatizadas y de bajo impacto, ya que están equipadas con sistemas de cogeneración energética. Los esfuerzos constantes por reducir completamente los residuos y las emisiones completan la imagen de una empresa centrada en la máxima sostenibilidad medioambiental.

La transizione ecologica è tra le priorità industriali dell'azienda. I nostri impianti sono conformi alle più stringenti normative internazionali, completamente automatizzati e a basso impatto, in quanto dotati di sistemi di cogenerazione energetica. Il costante impegno per la totale riduzione degli sprechi e delle emissioni completano il quadro di un'azienda orientata alla massima sostenibilità ambientale.

Der ökologische Wandel gehört zu den Prioritäten der industriellen Strategie des Unternehmens. Unsere Anlagen entsprechen den strengsten internationalen Richtlinien; sie arbeiten vollautomatisch und umweltschonend, denn sie sind mit Kraft-Wärme-Kopplungssystemen ausgerüstet. Ein weiterer Aspekt dieses Unternehmens, das sich ganz der Erreichung maximaler ökologischer Nachhaltigkeit verschrieben hat, ist sein kontinuierliches Engagement für die völlige Eliminierung von Verschwendung und Emissionen.

Экологический переход – один из основных технологических приоритетов компании. Наши производственные процессы отвечают требованиям строжайших международных стандартов, автоматизированы, оказывают минимальное воздействие на окружающую среду, а кроме того, на заводе работает собственная когенерационная установка. А еще мы принимаем меры по сокращению отходов и выбросов, что является еще одним свидетельством ориентации на экологическую устойчивость.

Porcelain and wall tiles: A safe choice

Resistance and duration

RESISTENZA E DURATA

Easy to maintain

Facile da mantenere

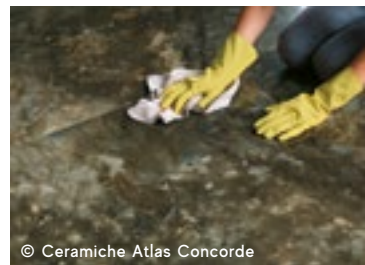

© Ceramiche Atlas Concorde

Porcelain tiles do not require any special maintenance.

Il gres porcellanato non richiede manutenzioni particolari.

UV Resistant

Resistente ai raggi UV



© Ceramiche Atlas Concorde

Porcelain tiles maintain their colors even when exposed to continuous, direct sunlight or in contact with atmospheric agents or smog.

Il gres porcellanato rimane inalterato nei suoi colori anche se esposto alla luce diretta e continua del sole o a contatto con agenti atmosferici o smog.

Scratch resistant

Resistente al graffio



© Ceramiche Atlas Concorde

Porcelain tiles do not splinter, break or get damaged.

Il gres porcellanato non si scheggia, non si rompe e non si danneggia.

Easy to clean

Facile da pulire



© Ceramiche Atlas Concorde

Porcelain tiles are easy to clean.

Il gres porcellanato si pulisce facilmente.

Waterproof

Resistente all'acqua



© Ceramiche Atlas Concorde

Porcelain tiles are completely non-porous and therefore are not damaged by water or humidity.

Il gres porcellanato è completamente non poroso e non teme l'acqua e l'umidità.

Stain resistant

Resistente alle macchie



© Ceramiche Atlas Concorde

Porcelain tiles are waterproof, no liquid can damage the surface.

Il gres porcellanato è impermeabile e nessun tipo di liquido può danneggiarne la superficie.

Resistant to chemicals

Resistente agli agenti chimici



© Ceramiche Atlas Concorde

Porcelain tiles do not stain and resist the most aggressive chemical agents.

Il gres porcellanato non si macchia e resiste agli agenti chimici più aggressivi.

Resistant to acids

Resistente agli acidi



© Ceramiche Atlas Concorde

Porcelain tiles are resistant to acids found in food and cleaning products.

Il gres porcellanato resiste agli acidi di uso alimentare e domestico.

Resistant to thermal shock

Resistente agli shock termici



© Ceramiche Atlas Concorde

A porcelain tile floor will not change as a result of sharp temperature fluctuations.

Un pavimento in gres porcellanato non si altera a causa di sbalzi termici.

Frost resistant

Resistente al ghiaccio



© Ceramiche Atlas Concorde

Porcelain tiles are frost resistant and therefore are not damaged by low temperatures.

Il gres porcellanato è ingelivo e resiste alle temperature più basse.

Health

SALUTE

Zero VOCS

Zero VOC



© Ceramiche Atlas Concorde

Porcelain tiles are intrinsically inorganic and do not emit volatile organic compounds (VOC).

Le piastrelle in gres porcellanato sono intrinsecamente inorganiche e non emettono composti organici volatili.

Zero PVC

Zero PVC



© Ceramiche Atlas Concorde

Porcelain tiles contain no PVC, plastics or petroleum derivatives.

Il gres porcellanato è privo di PVC, plastiche o derivati del petrolio.

Zero formaldehyde

Zero formaldeide



© Ceramiche Atlas Concorde

Porcelain tiles do not contain formaldehyde.

Il gres porcellanato non contiene formaldeide.

Zero allergens

Zero allergeni



© Ceramiche Atlas Concorde

Porcelain tiles are inhospitable for mites, bacteria, fungi, molds, and other irritants.

Il gres porcellanato è inospitale per acari, batteri, funghi, muffe e altre sostanze irritanti.

Prevent bacterial growth

Previene la crescita batterica



© Ceramiche Atlas Concorde

Porcelain tiles are completely hygienic and inhospitable for bacteria, mites, molds, and fungi.

Il gres porcellanato è assolutamente igienico e inospitale per i batteri, acari, muffe e funghi.

INDEX



OVERVIEW



IMAGE GALLERY



PRODUCT RANGE & TECHNICAL SPECS.



SUSTAINABILITY



THE BENEFITS OF CERAMIC TILES



ENJOY THE VIDEO

Safety

SICUREZZA

Non-slip

Antiscivolo



Porcelain tile surfaces can be made with an abrasive surface grit that can increase traction and reduce the risk of slipping.

Le superfici in gres porcellanato possono essere realizzate con una graniglia abrasiva superficiale in grado di aumentare la trazione e ridurre i rischi di scivolamento.

Fire resistant

Resistente al fuoco

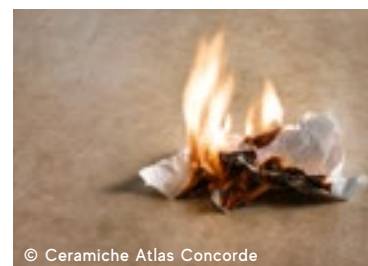

Porcelain tiles are not flammable, reduce the spread of flames, do not burn, and do not emit toxic fumes.

Le piastrelle in gres porcellanato non sono infiammabili, riducono la propagazione della fiamma, non bruciano e non emettono fumi tossici.

Heat resistant

Resistente al calore

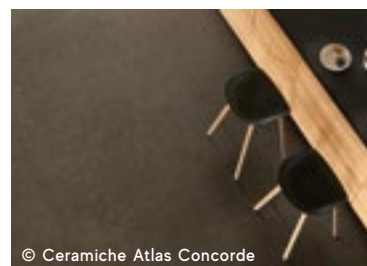

Porcelain tiles do not change shape at high temperatures.

Il gres porcellanato non si altera alle alte temperature.

Environment

AMBIENTE

Energy efficiency

Efficienza energetica

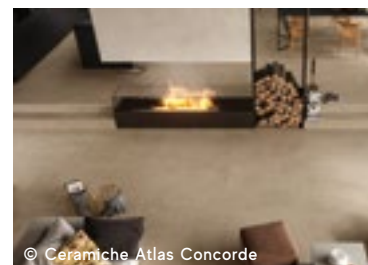

The high thermal inertia of porcelain tiles moderates the changes in temperature of the rooms, favoring energy savings.

L'elevata inerzia termica del gres porcellanato modera gli sbalzi di temperatura degli ambienti, favorendo il risparmio energetico.

Ecological

Ecologico



Porcelain tiles have a low environmental impact at all stages of their production, from the raw materials to disposal and recycling.

Il gres porcellanato ha un basso impatto ambientale in tutte le fasi del suo processo industriale, dalle materie prime fino allo smaltimento e al riciclo.

Recycling and re-use

Riciclo e riutilizzo



Porcelain tiles are made with recycled materials, last a long time, and can be re-used because they retain their original appearance.

Il gres porcellanato è realizzato con materiali di riciclo, dura a lungo e mantenendo l'aspetto originario può essere riciclato.

Ideal for floor heating systems

Ideale per sistemi di riscaldamento a pavimento



Porcelain tiles can be effectively combined with floor heating systems.

Il gres porcellanato può essere abbinato in modo efficace a sistemi di riscaldamento a pavimento.

Wall tiles additional benefits

PROPRIETÀ CERAMICA DA RIVESTIMENTO

Ease of installation

Facilità di lavorazione



Cuts, holes, and bevels are easily made and reduce the time it takes to lay the white body tiles.

Tagli, fori, bisellature sono facili da realizzare e rendono più veloce la posa dei rivestimenti in pasta bianca.

Extremely easy to clean

Estrema facilità di pulizia



White body ceramic tiles can be cleaned with a simple passage of hot water or neutral detergent.

I rivestimenti ceramici in pasta bianca si puliscono con un semplice passaggio di acqua calda o detergente neutro.

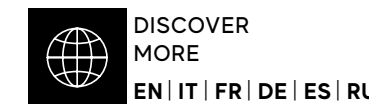

INDEX



OVERVIEW



IMAGE GALLERY



PRODUCT RANGE & TECHNICAL SPECS.



SUSTAINABILITY



THE BENEFITS OF CERAMIC TILES



ENJOY THE VIDEO

LE GRÈS CÉRAME : LE CHOIX SÛR / DAS FEINSTEINZEUG: EINE SICHERE WAHL / GRES PORCELÁNICO: LA ELECCIÓN SEGURA / КЕРАМИКА: НАДЕЖНЫЙ ВЫБОР

Résistance et longévité / Widerstandsfähigkeit und lebensdauer / Resistencia y durabilidad / Стойкость и долговечность

Entretien facile / Leicht zu warten / Fácil de mantener / Простота ухода

Le grès cérame n'exige aucun entretien particulier. / Feinsteinzeug erfordert keine besonderen Wartungsarbeiten. / El gres porcelánico no requiere particulares operaciones de mantenimiento. / Керамогранит не нуждается в особом уходе.

Résistant aux rayons UV / UV-Strahlenfest / Resistente a los rayos UV / Стойкость к УФ-излучению

Les coloris du grès cérame restent inaltérés même s'il est exposé à la lumière directe et continue du soleil ou au contact du smog et des agents atmosphériques. / Die Farben des Feinsteinzeugs bleiben unverändert erhalten, auch wenn es direktem und ständigem Sonnenlicht, der Witterung oder Smog ausgesetzt ist. / El gres porcelánico no se altera con el paso del tiempo, tampoco cambia su color cuando está expuesto a la luz directa y continua del sol o cuando entra en contacto con agentes climatológicos o contaminación. / Керамогранит не выцветает даже при постоянном воздействии солнечного света, атмосферных факторов, смога.

Résistant aux rayures / Kratzfestigkeit / Resistente a las rayas / Стойкость к царапинам

Le grès cérame ne subit ni ébréchures, ni cassures, ni dommages. / Feinsteinzeug splittert nicht, es zerbricht nicht und erleidet keine Beschädigungen. / El gres porcelánico no se desportilla, no se rompe y no se estropea. / Керамогранит не раскалывается, не ломается, не повреждается.

Facile à nettoyer / Leicht zu reinigen / De fácil limpieza / Легкость чистки

Le grès cérame se nettoie facilement. / Feinsteinzeug kann leicht gereinigt werden. / El gres porcelánico se limpia fácilmente. / Керамогранит легко очищается.

Résistant aux taches / Fleckenfestigkeit / Resistente a las manchas / Стойкость к пятнам

Le grès cérame est imperméable et aucun type de liquide ne peut endommager sa surface. / Feinsteinzeug ist wasserundurchlässig und Flüssigkeiten jeglicher Art können seine Oberfläche nicht beschädigen. / El gres porcelánico es impermeable y ningún tipo de líquido puede estropear la superficie. / Керамогранит непроницаем, и никакая жидкость не может повредить его поверхность.

Résistant aux agents chimiques / Beständigkeit gegen chemikalien / Resistente a los agentes químicos / Стойкость к химическим веществам

Le grès cérame ne se tache pas et résiste aux agents chimiques les plus agressifs. / Feinsteinzeug ist fleckenfest und beständig gegen die aggressivsten Chemikalien. / El gres porcelánico no se mancha y es resistente a los agentes químicos más agresivos. / Даже самые агрессивные химикаты не повреждают керамогранит и не оставляют на нем пятен.

Résistant aux acides / Beständigkeit gegen säuren / Resistente a los ácidos / Стойкость к кислотам

Le grès cérame résiste aux acides d'usage alimentaire et domestique. / Feinsteinzeug ist beständig gegen Säuren, die in Nahrungsmitteln oder im Haushalt verwendet werden. / El gres porcelánico es resistente a los ácidos de uso alimenticio y doméstico. / Керамогранит устойчив к кислотам, входящим в состав пищевых продуктов и средств бытовой химии.

Résistant aux écarts thermiques / Beständigkeit gegen thermoschocks / Resistente a los choques térmicos / Стойкость к перепадам температур

Un sol en grès cérame ne subit aucune altération suite aux écarts thermiques. / Ein Feinsteinzeug-Fußboden wird von Temperaturschwankungen nicht beeinträchtigt. / El pavimento de gres porcelánico no cambia a causa de cambios bruscos de temperatura. / Напольные покрытия из керамогранита не разрушаются при перепадах температуры.

Résistant à l'eau / Wasserfestigkeit / Resistente al agua / Стойкость к воде

Le grès cérame est absolument non poreux et ne craint ni l'eau ni l'humidité. / Feinsteinzeug ist absolut porös und fürchtet weder Wasser noch Feuchtigkeit. / El gres porcelánico no es poroso, no le penetra el agua y es resistente a la humedad. / Керамогранит – абсолютно непористый материал, поэтому не боится воды и влаги.

Résistant au gel / Frostbeständigkeit / Resistente a las heladas / Стойкость к морозам

Le grès cérame est ingélif et résiste aux températures les plus basses. / Feinsteinzeug ist frostbeständig und widersteht den niedrigsten Temperaturen. / El gres porcelánico es resistente a las heladas y a las bajas temperaturas. / Керамогранит способен противостоять морозам и низким температурам.

Santé / Gesundheit / Salud / Здоровье

Zéro allergène / Null allergene / Cero alérgenos / Ноль аллергенов

Le grès cérame est inhospitalier vis-à-vis des acariens, bactéries, champignons, moisissures et autres substances irritantes. / Feinsteinzeug ist unangstlich für Milben, Bakterien, Pilze, Schimmel und andere Reizstoffe. / El gres porcelánico es inhóspito para los ácaros, bacterias, hongos, mohos y otras sustancias irritantes. / На поверхности керамогранита не накапливаются клещи, бактерии, грибки, плесень и другие болезнетворные микроорганизмы.

Zéro COV / Null VOC / Cero VOC / Ноль летучих органических соединений

Les carreaux en grès cérame sont intrinsèquement inorganiques et ne libèrent aucun composé organique volatil. / Feinsteinzeugfliesen sind von Natur aus anorganisch und setzen keine flüchtigen organischen Verbindungen frei. / Las baldosas de gres porcelánico son intrínsecamente inorgánicas y no emiten compuestos orgánicos volátiles. / Керамогранит является неорганическим материалом и не выделяет летучих органических соединений.

Zéro formaldéhyde / Null formaldehyd / Cero formaldehído / Ноль формальдегида

Le grès cérame ne contient pas de formaldéhyde. / Feinsteinzeug ist formaldehydfrei. / El gres porcelánico non contiene formaldehído. / Керамогранит не содержит формальдегид.

Zéro PVC / Null PVC / Cero PVC / Ноль ПВХ

Le grès cérame est privé de PVC, de matières plastiques et de dérivés du pétrole. / Feinsteinzeug ist frei von PVC, Kunststoffen oder Petrolumderivaten. / El gres porcelánico no contiene PVC, plástico o sustancias que derivan del petróleo. / Керамогранит не содержит ПВХ, пластиковых материалов, нефтепродуктов.

Le grès cérame est fabriqué avec des matériaux recyclés, il dure longtemps en maintenant son aspect d'origine et il est recyclable. / Feinsteinzeug wird aus Recycling-Material hergestellt, hat eine lange Lebensdauer, erhält sein ursprüngliches Aussehen und kann recycelt werden. / El gres porcelánico está fabricado con materiales de reciclado, es duradero al paso del tiempo y se puede reciclar manteniendo el aspecto original. / Керамогранит изготавливается из переработанных материалов, долговечен, сохраняет во времени свои первоначальные характеристики и поддается переработке.

Il prévient la croissance bactérienne / Vorbeugung gegen das wachstum von bakterien / Previene la proliferación de bacterias / Предотвращение развития бактерий

Le grès cérame est absolument hygiénique et inhospitalier vis-à-vis des bactéries, acariens, moisissures et champignons. / Feinsteinzeug ist absolut hygienisch und unangstlich für Bakterien, Milben, Schimmel und Pilze. / El gres porcelánico es totalmente higiénico e inhóspito para las bacterias, ácaros, mohos y hongos. / Керамогранит абсолютно гигиеничен и препятствует развитию бактерий, клещей, плесени, грибка.

Sécurité / Sicherheit / Seguridad / Безопасность

Antiglisse / Rutschfestigkeit / Antideslizante / Препятствование скольжению

Recyclage et réutilisation / Recykling und wiederverwertung / Reciclaje y reutilización / Переработка и утилизация

Les surfaces en grès cérame peuvent être réalisées avec un fond superficiel abrasif en mesure d'augmenter la traction et réduire le risque de glissade. / Die Oberflächen des Feinsteinzeugs können mit die Reibung erhöhenden Splitten bereichert werden, welche die Trittsicherheit verbessern und die Gefahr von Ausrutschern mindern. / Las superficies de gres porcelánico se fabrican con una granalla abrasiva superficial en grado de aumentar la tracción y reducir los riesgos de deslizamiento. / На поверхность керамогранитной плитки в процессе изготовления может наноситься специальная абразивная крошка, которая увеличивает сцепление и снижает риск скольжения.

Résistant au feu / Feuerfestigkeit / Resistente al fuego / Огнестойкость

Les carreaux en grès cérame sont ininflammables, ils réduisent la propagation de la flamme, ne brûlent pas et de libèrent aucune fumée toxique. / Feinsteinzfiesen sind nicht entflammbar, sie mindern die Flammenausbreitung, brennen nicht und setzen keinen toxischen Rauch frei. / Las baldosas de gres porcelánico no son inflamables, reducen la propagación de las llamas, son resistentes al fuego y no emiten humos tóxicos. / Керамогранитная плитка не воспламеняется, ограничивает распространение огня, не горит, не выделяет токсичного дыма.

Résistant à la chaleur / Wärmebeständigkeit / Resistente al calor / Термостойкость

Le grès ne subit aucune altération aux températures élevées. / Feinsteinzeug wird von hohen Temperaturen nicht verändert. / El gres porcelánico no se altera con las altas temperaturas. / Керамогранит не повреждается под действием высоких температур.

The Benefits of Porcelain Tiles

PROPRIÉTÉS DE LA CÉRAMIQUE POUR REVÊTEMENTS / EIGENSCHAFTEN DER WANDFLIESEN / CARACTERÍSTICAS Y BENEFICIOS DE LA CERÁMICA PARA REVESTIMIENTO / СВОЙСТВА КЕРАМИЧЕСКОЙ ПЛИТКИ

INDEX

OVERVIEW

IMAGE GALLERY

Facilité de travail / Verarbeitungsfreundlichkeit / Fácil de trabajar / Легкость обработки

Nettoyage extrêmement facile / Extrem einfache Reinigung / Máxima facilidad de limpieza / Предельная простота ухода

Les découpes, les perçages et les biseautages sont faciles à réaliser et rendent plus rapide la pose des carrelages en pâte blanche. / Schnitte, Bohrungen, Abkantungen sind leicht zu verwirklichen, daher können weißscherbige Keramikbeläge überall schneller verlegt werden. / Cortes, perforaciones y biselados se realizan fácilmente y la instalación de los revestimientos de pasta blanca se hace con rapidez. / Легкость резки, сверления, скашивания граней ускоряет процесс укладки настенной плитки из белой глины.

Nettoyage extrêmement facile / Extrem einfache Reinigung / Máxima facilidad de limpieza / Предельная простота ухода

Les carrelages céramiques en pâte blanche se nettoient simplement avec de l'eau chaude ou avec un détergent neutre. / Die weißscherbigen Keramikbeläge werden einfach durch Abwischen mit warmem Wasser oder einem neutralen Putzmittel gereinigt. / Los revestimientos cerámicos de pasta blanca se limpian pasando un trapo húmedo con agua caliente o detergente neutro. / Настенная плитка из белой глины очищается теплой водой или нейтральным моющим средством.

SUSTAINABILITY

THE BENEFITS OF CERAMIC TILES

ENJOY THE VIDEO



Ceramiche Atlas Concorde S.p.A.
Via Canaletto 141
41042 Spezzano di Fiorano (MO) - Italia

Atlas Concorde USA, Inc.
117 Seaboard Lane - Suite F170
Franklin, TN 37067 - USA

Atlas Concorde Russia
Business centre "Meliora Place"
Prospekt Mira 6
129090 Moscow - Russia

atlasconcorde.com

Copyright 2022 by Ceramiche Atlas Concorde S.p.A.
(Spezzano di Fiorano, MO - Italy)
January 2022