SOAP STONE

STONE
SOUL

FIVE
SIZES

5
COLORS

PORCELAIN STONEWARE

MADE IN ITALY

CERCOM[®]

Design your life



Impiegata da secoli nell'arte e nell'artigianato, **la pietra saponaria** si lascia plasmare, scolpire e levigare per rivelare eleganti trame venate e colori affascinanti //

Utilized for centuries in art and craftsmanship, **soap stone** can be shaped, sculpted and smoothed to reveal elegant veined textures and fascinating colours //

Utilisée depuis des siècles dans l'art et l'artisanat, **la pierre ollaire** peut être façonnée, sculptée et polie pour révéler d'élégantes textures veinées et des couleurs fascinantes //

Der seit Jahrhunderten in Kunst und Handwerk zum Einsatz kommende **Speckstein** lässt sich hervorragend formen, modellieren und glätten und enthüllt dabei elegante Texturen und faszinierende Farben //

Мыльный камень, уже много веков используемый в художественной сфере и для создания изделий народных промыслов, легко поддается обработке, резьбе и полировке, раскрывая элегантный рисунок своих прожилок и очаровательную цветовую палитру //

INTO THE SOLUTIONS



RANGE
DETAILS

FIVE
SIZES

THREE
FINISHINGS

100x100
40"x40"

120x120
48"x48"

60x120
24"x48"

60x120
24"x48"
2CM

60x60
24"x24"

30x60
12"x24"

NAT

ROCK R11

SATIN

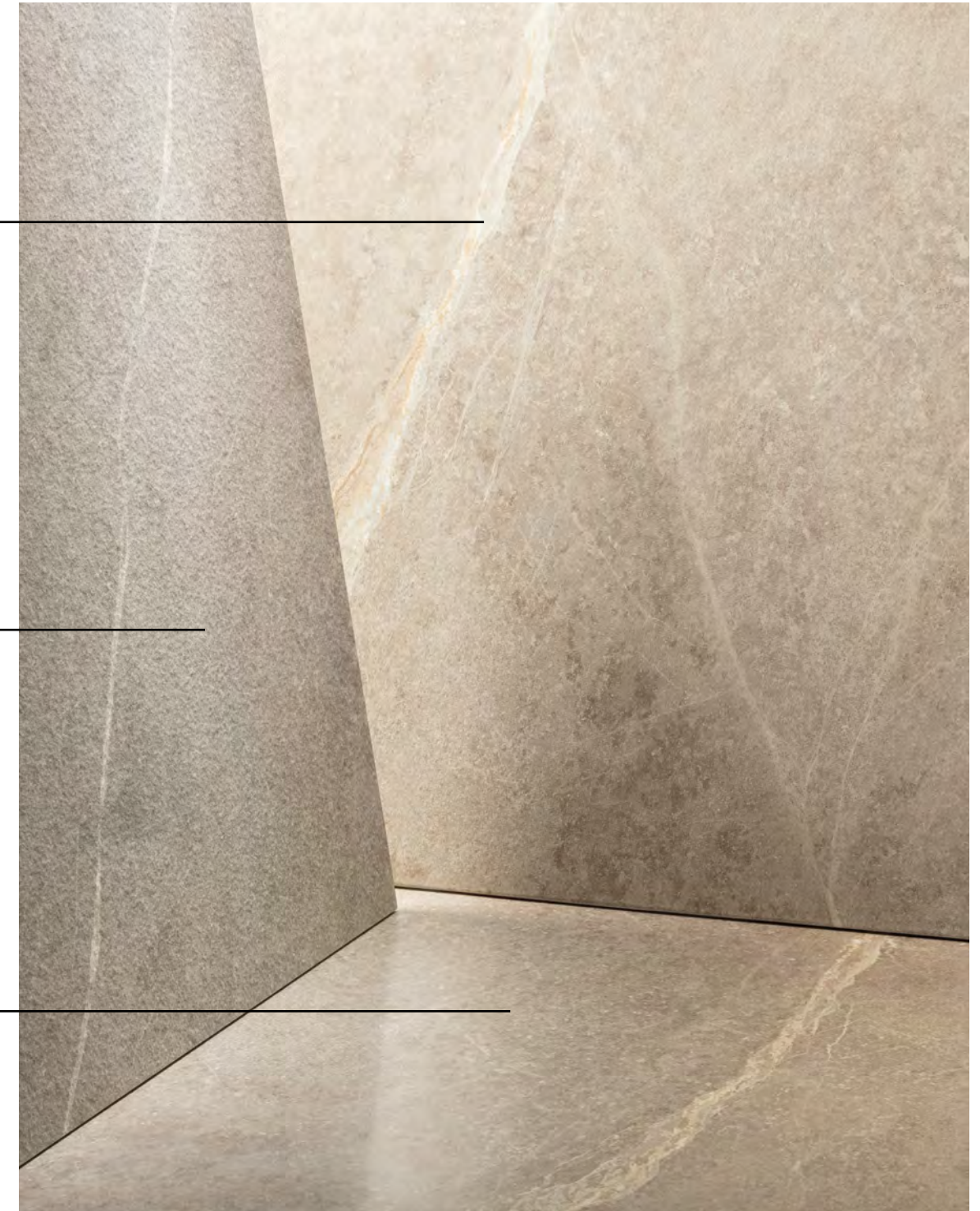

RANGE
DETAILS

5
COLORS

COMMERCIAL



RESIDENTIAL



8,5 mm NAT		100x100	40"x40"	✓	✓	✓	✓	✓	✓
9,5 mm NAT SATIN ROCK R11		30x60	12"x24"	✓	✓	✓	✓	✓	✓
		60x60	24"x24"	✓	✓	✓	✓	✓	✓
		60x120	24"x48"	✓	✓	✓	✓	✓	✓
9,5 mm NAT		120x120	48"x48"	✓	✓	✓	✓	✓	✓
20 mm ROCK R11		60x120	24"x48"		✓	✓	✓		

APPLICATIONS GALLERIES

A // HOME GALLERY



28 LIVING
WHITE



40 LIVING
COFFEE



30 BEDROOM
IVORY + COFFEE



24 KITCHEN
WHITE + GREY + BLACK

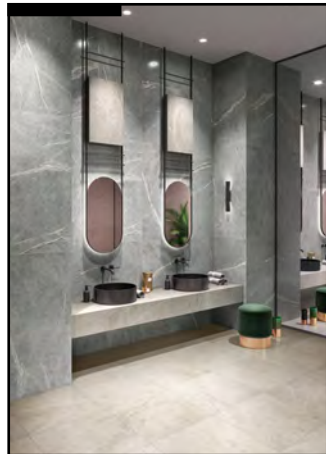

18 BATHROOM
WHITE + GREY

B // CONTRACT GALLERY

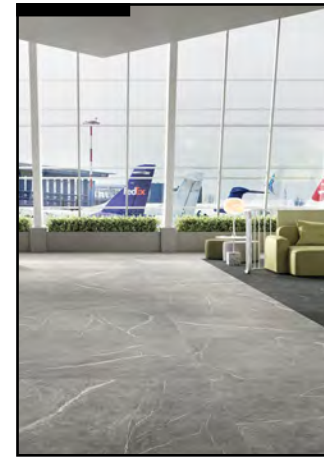

10 AIRPORT
GREY + BLACK



16 AIRPORT
GREY + IVORY



14 LOUNGE
BLACK + WHITE



32 COFFEE
IVORY

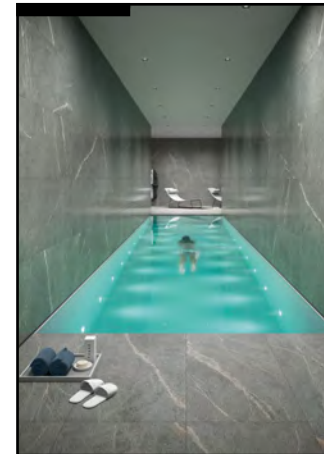

20 WELLNESS
GREY

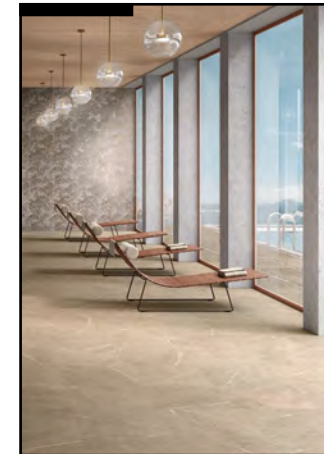

34 RESORT
IVORY + COFFEE

**B // CONTRACT AIRPORT
GREY + BLACK**

floor

GREY 120x120 . 48"x48" RETT

BLACK 60x120 . 24"x48" RETT

#3D
VEINS



**B // CONTRACT LOUNGE
BLACK + WHITE**

floor
BLACK 120x120 . 48"x48" RETT

wall
WHITE 60x120 . 24"x48" SATIN-RETT



B // CONTRACT AIRPORT GREY + IVORY

floor indoor
GREY 100x100 . 40"x40" RETT

floor outdoor
IVORY ROCK R11 60x120 . 24"x48" RETT

wall
GREY 60x120 . 24"x48" RETT
OAK GREY 60x120 . 24"x48" RETT

#MULTIPLE
GRAPHICS

**A // HOME BATHROOM
WHITE + GREY**

floor
WHITE 60x60 . 24"x24" SATIN-RETT

wall
GREY 60x120 . 24"x48" SATIN-RETT
GREY MOSAICO 3D 30x60 . 12"x24" RETT

furniture
WHITE



**B // CONTRACT WELLNESS
GREY**

floor
GREY ROCK R11 60x120 . 24"x48" RETT

wall
GREY 60x120 . 24"x48" SATIN-RETT



GREY ROCK R11 60x120 . 24"x48" RETT





wall
GREY 100x100 . 40"x40" RETT

floor
BLACK 100x100 . 40"x40" RETT

furniture
BLACK



**A // HOME KITCHEN
WHITE + GREY + BLACK**

floor indoor
WHITE 60x120 . 24"x48" SATIN-RETT

floor outdoor
GREY ROCK R11 60x60 . 24"x24" RETT

wall
BLACK MOSAICO 5x5 . 2"x2" RETT



#IN&OUT
COORDINATED

wall
BLACK MOSAICO 5x5 . 2"x2" RETT



floor
WHITE 60x60 . 24"x24" SATIN-RETT



#SATIN
FINISH



**A // HOME LIVING
WHITE**

floor
WHITE 60x120 . 24"x48" SATIN-RETT

wall
WHITE MOSAICO 3D 30x60 . 12"x24" RETT



**A // HOME BEDROOM
IVORY + COFFEE**

floor
IVORY 60x60 . 24"x24" SATIN-RETT

wall
COFFEE MOSAICO 5x5 . 2"x2" RETT





**B // CONTRACT COFFEE
IVORY**

floor
IVORY 60x60 . 24"x24" RETT

wall
IVORY MOSAICO 5x5 . 2"x2" RETT



**B // RESORT
IVORY + COFFEE**

floor indoor
IVORY 60x120 . 24"x48" RETT

floor outdoor
COFFEE ROCK R11 2CM 60x120 . 24"x48" RETT

wall
OAK COFFEE 60x120 . 24"x48" RETT





#SPECIAL
DECOR

floor indoor
IVORY 60x120 . 24"x48" RETT

wall
OAK COFFEE 60x120 . 24"x48" RETT



floor outdoor
COFFEE ROCK R11 2CM OUTDOOR 60x120 . 24"x48" RETT



#2CM
THICKNESS

A // HOME LIVING
COFFEE

floor
COFFEE 60x120 . 24"x48" SATIN-RETT

wall
MOSAICO SOAP MIX 30x42 . 12"x16 9/16" RETT





floor
COFFEE 60x120 . 24"x48" SATIN-RETT

wall
MOSAICO SOAP MIX 30x42 . 12"x16 9/16" RETT





WHITE

GRES PORCELLANATO SMALTATO COLORATO IN MASSA . GLAZED PORCELAIN STONEWARE WITH COLOURED BODY . GRÈS CÉRAME ÉMAILLÉ COLORÉ DANS LA MASSE . GLASIERTES FEINSTEINZEUG IN DER MASSE GEFÄRBT . ГЛАЗУРОВАННЫЙ КЕРАМОГРАНИТ, ОКРАШЕННЫЙ ПО ВСЕЙ ТОЛЩИНЕ



Sizes

	NAT	SATIN	ROCK R11
 100x100 . 40"x40" RETT	<input type="checkbox"/>		
 120x120 . 48"x48" RETT	<input type="checkbox"/>		
 60x120 . 24"x48" RETT	<input type="checkbox"/>	<input type="checkbox"/>	<input type="checkbox"/>
 60x60 . 24"x24" RETT	<input type="checkbox"/>	<input type="checkbox"/>	<input type="checkbox"/>
 30x60 . 12"x24" RETT	<input type="checkbox"/>	<input type="checkbox"/>	<input type="checkbox"/>

Mosaics

	NAT
 Mosaico Tessera 5x5 . 2"x2" 30x30 . 12"x12" RETT	<input type="checkbox"/>
 Mosaico Soap 3D 30x60 . 12"x24" RETT	<input type="checkbox"/>
 Mosaico Soap Mix 30x42 . 12"x16 9/16" RETT	<input type="checkbox"/>

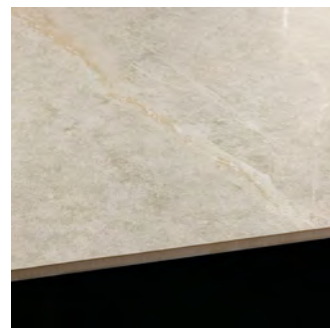

NAT
R10 RETT



ROCK
R11 RETT

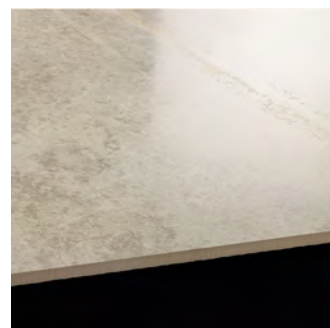

SATIN
RETT



IVORY

GRES PORCELLANATO SMALTATO COLORATO IN MASSA . GLAZED PORCELAIN STONEWARE WITH COLOURED BODY . GRÈS CÉRAME ÉMAILLÉ COLORÉ DANS LA MASSE . GLASIERTES FEINSTEINZEUG IN DER MASSE GEFÄRBT . ГЛАЗУРОВАННЫЙ КЕРАМОГРАНИТ, ОКРАШЕННЫЙ ПО ВСЕЙ ТОЛЩИНЕ



Sizes

	NAT	SATIN	ROCK R11
 100x100 . 40"x40" RETT	<input type="checkbox"/>		
 120x120 . 48"x48" RETT	<input type="checkbox"/>		
 60x120 . 24"x48" RETT	<input type="checkbox"/>	<input type="checkbox"/>	<input type="checkbox"/>
 60x60 . 24"x24" RETT	<input type="checkbox"/>	<input type="checkbox"/>	<input type="checkbox"/>
 30x60 . 12"x24" RETT	<input type="checkbox"/>	<input type="checkbox"/>	<input type="checkbox"/>
 60x120 . 24"x48" RETT			<input type="checkbox"/>

Mosaics

	NAT
 Mosaico Tessera 5x5 . 2"x2" 30x30 . 12"x12" RETT	<input type="checkbox"/>
 Mosaico Soap 3D 30x60 . 12"x24" RETT	<input type="checkbox"/>
 Mosaico Soap Mix 30x42 . 12"x16 9/16" RETT	<input type="checkbox"/>

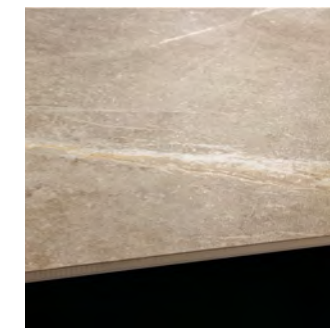

NAT
R10 RETT



ROCK
R11 RETT

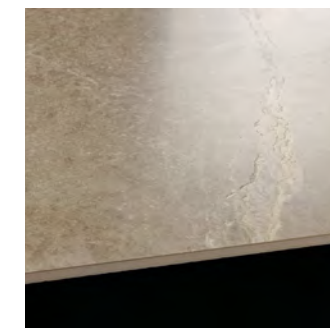

SATIN
RETT



GREY

GRES PORCELLANATO SMALTATO COLORATO IN MASSA . GLAZED PORCELAIN STONEWARE WITH COLOURED BODY . GRÈS CÉRAME ÉMAILLÉ COLORÉ DANS LA MASSE . GLASIERTES FEINSTEINZEUG IN DER MASSE GEFÄRBT . ГЛАЗУРОВАННЫЙ КЕРАМОГРАНИТ, ОКРАШЕННЫЙ ПО ВСЕЙ ТОЛЩИНЕ



Sizes

	NAT	SATIN	ROCK R11
	<input type="checkbox"/>		
	<input type="checkbox"/>		
	<input type="checkbox"/>	<input type="checkbox"/>	<input type="checkbox"/>
	<input type="checkbox"/>	<input type="checkbox"/>	<input type="checkbox"/>
	<input type="checkbox"/>	<input type="checkbox"/>	<input type="checkbox"/>
	<input type="checkbox"/>		
			<input type="checkbox"/>

Mosaics

	NAT
 Mosaico Tessera 5x5 . 2\"x2\" 30x30 . 12\"x12\" RETT	<input type="checkbox"/>
	<input type="checkbox"/>
	<input type="checkbox"/>

Pezzi speciali . Special pieces . Pièces spéciales
 Formteile . Специальные элементы: Pag. 50/51

NAT
R10 RETT

ROCK
R11 RETT

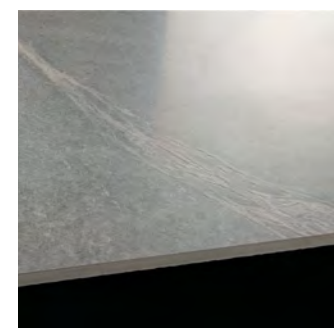

SATIN
RETT



COFFEE

GRES PORCELLANATO SMALTATO COLORATO IN MASSA . GLAZED PORCELAIN STONEWARE WITH COLOURED BODY . GRÈS CÉRAME ÉMAILLÉ COLORÉ DANS LA MASSE . GLASIERTES FEINSTEINZEUG IN DER MASSE GEFÄRBT . ГЛАЗУРОВАННЫЙ КЕРАМОГРАНИТ, ОКРАШЕННЫЙ ПО ВСЕЙ ТОЛЩИНЕ



Sizes

	NAT	SATIN	ROCK R11
	<input type="checkbox"/>		
	<input type="checkbox"/>		
	<input type="checkbox"/>	<input type="checkbox"/>	<input type="checkbox"/>
	<input type="checkbox"/>	<input type="checkbox"/>	<input type="checkbox"/>
	<input type="checkbox"/>	<input type="checkbox"/>	<input type="checkbox"/>
	<input type="checkbox"/>		
			<input type="checkbox"/>

NAT
R10 RETT

ROCK
R11 RETT

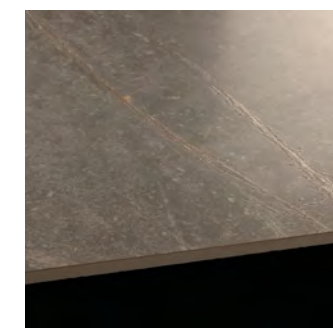

SATIN
RETT

Mosaics

	NAT
 Mosaico Tessera 5x5 . 2\"x2\" 30x30 . 12\"x12\" RETT	<input type="checkbox"/>
	<input type="checkbox"/>
	<input type="checkbox"/>

Pezzi speciali . Special pieces . Pièces spéciales
 Formteile . Специальные элементы: Pag. 50/51



BLACK

GRES PORCELLANATO SMALTATO COLORATO IN MASSA . GLAZED PORCELAIN STONEWARE WITH COLOURED BODY . GRÈS CÉRAME ÉMAILLÉ COLORÉ DANS LA MASSE . GLASIERTES FEINSTEINZEUG IN DER MASSE GEFÄRBT . ГЛАЗУРОВАННЫЙ КЕРАМОГРАНИТ, ОКРАШЕННЫЙ ПО ВСЕЙ ТООЛЩИНЕ



Sizes

	NAT	SATIN	ROCK R11
 100x100 . 40"x40" RETT	<input type="checkbox"/>		
 120x120 . 48"x48" RETT	<input type="checkbox"/>		
 60x120 . 24"x48" RETT	<input type="checkbox"/>	<input type="checkbox"/>	<input type="checkbox"/>
 60x60 . 24"x24" RETT	<input type="checkbox"/>	<input type="checkbox"/>	<input type="checkbox"/>
 30x60 . 12"x24" RETT	<input type="checkbox"/>	<input type="checkbox"/>	<input type="checkbox"/>

Mosaics

	NAT
 Mosaico Tessera 5x5 . 2"x2" 30x30 . 12"x12" RETT	<input type="checkbox"/>
 Mosaico Soap 3D 30x60 . 12"x24" RETT	<input type="checkbox"/>
 Mosaico Soap Mix 30x42 . 12"x16 9/16" RETT	<input type="checkbox"/>



NAT
R10 RETT

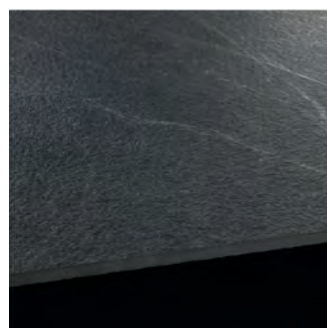

ROCK
R11 RETT

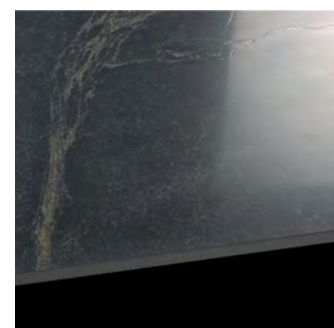

SATIN
RETT

Pezzi speciali . Special pieces . Pièces spéciales
 Formteile . Специальные элементы: Pag. 50/51



MOSAICI

MOSAICS . MOSAIQUES . MOSAIKEN . МОЗАИКА

MOSAICO TESSERA

WHITE 30x30 . 12"x12" RETT tessera 5x5 . 2"x2"	IVORY 30x30 . 12"x12" RETT tessera 5x5 . 2"x2"	GREY 30x30 . 12"x12" RETT tessera 5x5 . 2"x2"	COFFEE 30x30 . 12"x12" RETT tessera 5x5 . 2"x2"	BLACK 30x30 . 12"x12" RETT tessera 5x5 . 2"x2"

MOSAICO SOAP 3D

WHITE 30x60 . 12"x24" RETT	IVORY 30x60 . 12"x24" RETT	GREY 30x60 . 12"x24" RETT
COFFEE 30x60 . 12"x24" RETT	BLACK 30x60 . 12"x24" RETT	

MOSAICO SOAP MIX

30x42 . 12"x16 9/16" RETT

DECORI

DECORS . DÉCORS . DEKORE . ДЕКОРЫ



OAK GREY
60x120 . 24"x48" RETT



OAK COFFEE
60x120 . 24"x48" RETT

PEZZI SPECIALI

TRIMS . PIÈCES SPÉCIALES . FORMSTÜCKE . СПЕЦИАЛЬНЫЕ ИЗДЕЛИЯ



Battiscopa
6,5x100 . 2 9/16"x40" RETT



Battiscopa
6,5x60 . 2 9/16"x24" RETT

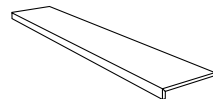

Gradone costa retta
30x120x3,3 . 12"x48"x1 5/16" RETT

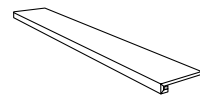

Gradone square assemblato
30x120x3,3 . 12"x48"x1 5/16" RETT

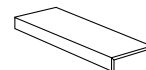

Elemento ad "L" assemblato R11
15x60x5 . 6"x24"x2" RETT



Coppia Angolo Griglia (2 pz) R11
20x60 . 8"x24" RETT

Step Molato R11
30x120 . 12"x48" RETT

Step Torato R11
30x120 . 12"x48" RETT

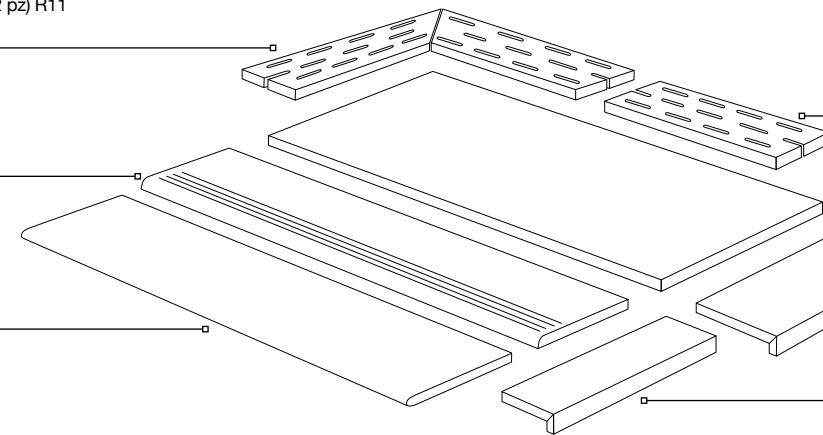

Griglia per Piscina R11
20x60 . 8"x24" RETT

60x120 R11 . 24"x48" RETT

Costa Retta R11
30x60x5 . 12"x24"x2" RETT

















Elemento ad "L" assemblato R11
15x60x5 . 6"x24"x2" RETT

PACKING

	PCS // BOX	SQM // BOX	KGS // BOX	BOXES // PALLET	SQM // PALLET	KGS // PALLET
8,5 MM 5/16"						
100x100 . 40"x40" RETT	1	1,00	19,00	42	42,00	814
	2	2,00	38,00	24	48,00	950
6,5x100 . 2 9/16"x40" BATTISCOPIA RETT	6	6,00 ml	9,00			
9,5 MM 3/8"						
120x120 . 48"x48" RETT	1	1,44	31,00	40	57,60	1.300
60x120 . 24"x48" RETT/SATIN/ROCK	2	1,44	31,00	36	51,84	1.144
60x60 . 24"x24" RETT/SATIN/ROCK	3	1,08	22,80	40	43,20	928
30x60 . 12"x24" RETT/SATIN/ROCK	6	1,08	22,80	40	43,20	928
6,5x60 . 2 9/16"x24" BATTISCOPIA RETT	12	7,20 ml	11,00			
20 MM 13/16"						
60x120 . 24"x48" RETT	1	0,72	32,30	36	25,92	1.190

CARATTERISTICHE TECNICHE

TECHNICAL FEATURES . CARACTÉRISTIQUES TECHNIQUES . TECHNISCHE EIGENSCHAFTEN . ТЕХНИЧЕСКИЕ ХАРАКТЕРИСТИКИ

GRES PORCELLANATO SMALTATO COLORATO IN MASSA - ISO 13006 Bla GL GLAZED PORCELAIN STONWARE WITH COLOURED BODY . GRÈS CÉRAMÉ ÉMAILLÉ COLORÉ DANS LA MASSE GLASIERTES FEINSTEINZEUG IN DER MASSE GEFÄRBT - ГЛАЗУРОВАННЫЙ КЕРАМОГРАНИТ, ОКРАШЕННЫЙ ПО ВСЕЙ ТООЛЩИНЕ			
	Aspetto superficiale Surface appearance Aspect superficiel Oberflächenbeschaffenheit Вид поверхности	≥ 95%	Conforme Compliant Conforme Konform Соответствует
	Lunghezza e larghezza Length and width Longueur et largeur Länge und Breite Длина и ширина	Deviazione valore medio % rispetto a dimensione di fabbricazione. Deviation of the average size for each tile from the work size (%). Écart dimensionnel moyen en % par rapport aux dimensions de fabrication. Abweichung des Durchschnittswertes in % hinsichtlich der Produktionsgröße. Отклонение средн. значения, %, от производственных размеров > 410 cm2 +/- 0,6% - ≤ 410 cm2 +/- 0,75%	± 0,5% ± 1,5 mm
		Deviazione valore medio % rispetto a dimensione di fabbricazione. Deviation of the average size for each tile from the average size to the 10 test specimens (%). Écart de valeur moyenne unitaire % en rapport à la valeur moyenne de 10 échantillons mesurés. Abweichung des Durchschnittswertes der einzelnen Fliesen in % hinsichtlich des Durchschnitts von 10 getesteten Mustern. Отклонение средн. значения, отдельной плитки относительно средн. значения 10 измеренных образцов +/- 0,5%	± 0,5% ± 1,5 mm
	Rettilinearità degli spigoli Straightness of sides Rectitude des arêtes Kantengeradheit Прямолинейность кромок	+/- 0,5%	± 0,3% ± 1,5 mm
	Spessore / Thickness / Épaisseur/ Stärke / Толщина	+/- 5%	± 5% ± 0,5 mm
	Ortogonalità Rectangularity Orthogonalité Rechtwinkigkeit Ортогональность	+/- 0,5%	± 0,3% ± 1,5 mm
	Assorbimento d'acqua Water absorption Absorption d'eau Wasseraufnahme Водопоглощение	≤ 0,5% GRUPPO Bla GL	E ≤ 0,1%
	Resistenza della superficie (scala MOHS) Scratch hardness (MOHS scale) Dureté de la surface (échelle MOHS) Oberflächenhärte (MOHS skala) Поверхностная прочность по (шкале Мооса)	EN 101	> 6
	Resistenza a flessione e forza di rottura Modulus of rupture and breaking strength résistance à la flexion et force de rupture Biegefestigkeit und Bruchlast Прочность на изгиб Модуль жесткости	S ≥ 1300 N	S ≥ 1300 N
		R ≥ 35 N/mm ²	R ≥ 35 N/mm ²
	Resistenza alla abrasione della superficie di piastrelle smaltate Resistance to surface abrasion of glazed tiles Résistance à l'abrasion de la surface des carreaux émaillés Widerstand gegen Abrieb der Oberfläche der glasierten Fliesen Стойкость глазурованной плитки к поверхностному истиранию	Come dichiarato dal produttore See manufacturer's declaration Selon déclaration du producteur Entsprechend der Herstellerangaben Как указано изготовителем	Classe 3-4-5 Class 3-4-5 Classe 3-4-5 Gruppe 3-4-5 Класс 3-4-5
	Coefficiente di dilatazione termica lineare Linear thermal expansion coefficient Dilatation thermique linéaire Lineare Wärmeausdehnung Кэффициент линейного теплового расширения	Come dichiarato dal produttore See manufacturer's declaration Selon déclaration du producteur Entsprechend der Herstellerangaben Как указано изготовителем	Metodo disponibile Method available Méthode disponible Verfügbares Verfahren Определяется производителем
	Resistenza allo shock termico Thermal shock resistance Résistance au choc thermique Temperaturwechselbeständigkeit Стойкость к тепловым перепадам	Nessun campione deve presentare alterazioni No sample must show visible alteration Aucun carreau ne doit présenter d'altération Kein Muster darf sichtbare Veränderungen zeigen Никакой образец не должен показывать изменений	Resistente Resistant Widerstandsfähig Устойчивый
	Resistenza al gelo Frost resistance Résistance au gel Frostbeständigkeit Морозостойкость	Non devono presentare difetti visibili No sample must show visible defect Aucun carreau ne doit présenter de défaut Muster dürfen keine sichtbaren Schäden zeigen Не должны обнаруживать видимые дефекты	Ingelivo Frost proof ingelif Frostsischer Морозостойкость
	Resistenza all'attacco chimico (tranne acido fluoridrico) Resistance to chemical attack (except hydrofluoric acid) Résistance à l'attaque chimique (sauf acide fluorhydrique) Säure- und Laugenbeständigkeit (außer Flußsäure) Стойкость к бытовым химикатам	Nessun campione deve presentare alterazioni No sample must show visible alteration Aucun carreau ne doit présenter d'altération Muster dürfen keine sichtbaren Veränderungen zeigen Никакой образец не должен показывать изменений	Classe A-HA-LA Class A-HA-LA Classe A-HA-LA Gruppe A-HA-LA Класс A-HA-LA
	Resistenza alle macchie di piastrelle smaltate Resistance to stains of glazed tiles Résistance aux taches des carreaux émaillés Widerstand gegen Fleckenbildner der glasierten Fliesen Стойкость глазурованной плитки к образованию пятен	Nessun campione deve presentare alterazioni No sample must show visible alteration Aucun carreau ne doit présenter d'altération Muster dürfen keine sichtbaren Veränderungen zeigen Никакой образец не должен показывать изменений	Classe 5 Class 5 Classe 5 Gruppe 5 Класс 5
	Resistenza alla scivolosità. Coefficiente di attrito medio Skid resistance. Average coefficient of friction Résistance au glissement. Coefficient de frottement moyen Rutschfestigkeit. Mittlerer Reibungswert Сопротивление скольжению. Средний коэффициент трения	B.C.R.A. REP. CEC. 6/81 (NO SATIN-RETT - NO LUX - NO SATIN)	
		DIN 51130 ≥ R 9 (NO SATIN-RETT - NO LUX - NO SATIN)	
	Pendulum Australian AS 4586	DIN 51097 (NO SATIN-RETT - NO LUX - NO SATIN)	
		DCOF	
	Pendulum Britanico BS 7976	R10	
		R11	
		Classe B	Classe C
		Class B	Class C
		Classe B	Classe C
		Gruppe B	Gruppe C
		Kласс B	Kласс C
		f ^h ≥ 0,42	
		R10: Classe P3 Class P3 Classe P3 Gruppe P3 Класс P3	R11: Classe P4 Class P4 Classe P4 Gruppe P4 Класс P4
		PTV > 36 wet	

// ufoadv.com



TILES FOR LIFE



Design your life

Via A. Volta 23/25 - 42013 Casalgrande (Re) Italy
Tel. +39-0522-998911/411
Fax Italy +39-0522-998910
Fax Export +39-0522-998930/996218



Ceramics of Italy

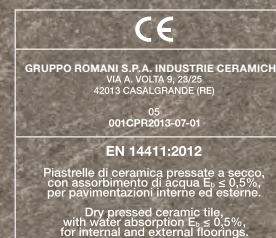

© Copyright 2022 Gruppo Romani S.p.A.
Gruppo Romani S.p.A. Industrie Ceramiche
www.grupporomanispa.com



SOAP STONE

#SIZE

120x120
48"x48"

100x100
40"x40"

60x120
24"x48"

60x60
24"x24"

30x60
12"x24"

#COLORS

WHITE

IVORY

GREY

COFFEE

BLACK

#SURFACES

NAT

SATIN

ROCK R11

Cercom is a brand of