

ROMA

Eterna bellezza



FAP
CERAMICHE
Naturalmente casa.

ROMA

Eterna bellezza

10

STATUARIO

38

GRAFITE

50

TRAVERTINO

58

PIETRA

68

IMPERIALE

82

CALACATTA





WALL & FLOOR

Roma è un progetto ceramico completo di pavimenti e rivestimenti per circondare di bellezza i vostri spazi.

Roma is a complete ceramic programme of floor and wall tiles to encase your rooms with a sensation of beauty.

Roma représente un projet céramique complet composé de sols et de murs qui saura valoriser vos espaces de vie. / Roma ein vollständiges Keramikprojekt für Fußböden und Verkleidungen der Ihren Raum mit Schönheit umgibt. / Roma es un proyecto cerámico completo de pavimentos y revestimientos para inundar vuestros espacios de belleza. / Roma — это универсальный проект напольной и настенной плитки, привносящей в ваш дом истинную красоту.

MARMO E PIETRA MARBLE & STONE

Roma esprime con fascino contemporaneo la bellezza del marmo e della pietra. Sei colori interpretano con grandi lastre una nuova estetica progettuale, senza limiti, senza tempo.

Roma lends contemporary appeal to the beauty of marble and stone. Six colours and large slabs for a new aesthetic project that is timeless and knows no limits.



MARBRE ET PIERRE. Roma exprime la beauté du marbre et de la pierre avec un charme contemporain. Sur de grandes plaques, six couleurs interprètent une nouvelle esthétique conceptuelle, sans limite et sans contrainte. / MARMOR UND STEIN. Roma bringt die Schönheit des Marmors und des Steins mit zeitgemäßen Charme zum Ausdruck. Sechs Farben interpretieren mit großen Platten eine neue Planungsästhetik, grenzenlos und zeitlos. / MARMOL Y PIEDRA. Roma refleja con un moderno atractivo la belleza del mármol y de la piedra. Seis colores interpretan junto con grandes losas una nueva estética proyectual sin límites ni tiempo. / Мрамор и КАМЕНЬ. Roma передает в современном ключе красоту мрамора и камня. В шести тональностях крупноформатной плитки выражена новая дизайнерская эстетика: без границ и вне времени.



PAVIMENTI MATT E LUX MATT & LUX FLOOR

*Due superfici, due sensazioni:
Matt per un effetto sofisticato
e contemporaneo, Lux per un
risultato morbido, leggermente
cerato.*

*Two finishes, two sensations: Matt
for a sophisticated and contem-
porary effect, Lux for a soft and
lightly waxed effect.*

SOLS MATT ET LUX. Deux surfaces,
deux sensations : Matt pour un effet
sophistiqué et contemporain, Lux pour
un aspect doux, légèrement ciré. /
FUSSBODEN MATT UND LUX. Zwei
verschiedene Oberflächen, zwei ver-
schiedene Empfindungen: Matt für ein-
en anspruchsvollen und zeitgemäßen
Effekt, Lux für ein sanftes Ergebnis
welches leicht eingewachst wirkt. /
PAVIMENTOS MATT Y LUX. Dos su-
perficies, dos sensaciones: Matt para
un efecto sofisticado y moderno; Lux
para un resultado suave, ligeramente
encerado. / НАПОЛЬНАЯ ПЛИТКА
МАТТ И LUX. Две поверхности,
два ощущения: Матт - изысканный
современный эффект, Лух — эффект
мягкости и легкого вощения.

MATT

LUX

STATUARIO

puro e perfetto / pure and perfect

pur et parfait
Perfekt und rein
puro y perfecto
чистая и безупречная

PASTA BIANCA
WHITE BODY

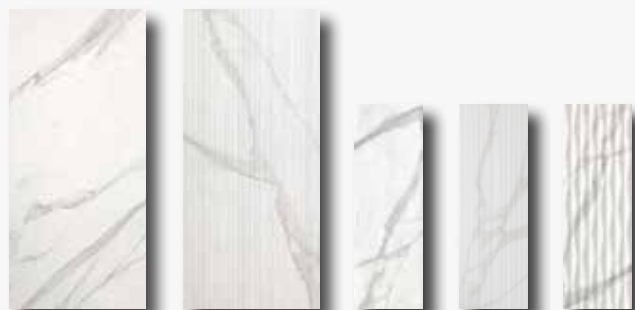

50x120 RT

50x120 RT

25x75

25x75

25x75

GRES PORCELLANATO
PORCELAIN STONEWARE



80x160 RT

80x80 RT

60x60 RT

30x60 RT

ATELIER



21,6x25

20x20

7,5x30



MY LIVING

Pavimento e rivestimento, il puro fascino dello Statuario e del grande formato.

Wall and floor coverings, the pure attraction of Statuario and large size.



Sols et murs, le charme de Statuario et du grand format à l'état pur. / Fußboden und Wandverkleidung, der reine Charme des Statuario und des großen Formats. / Pavimento y revestimiento, la atracción pura del Statuario y del gran formato. / Настенная и напольная плитка, непревзойденное очарование линии Statuario и крупного формата.



Wall
Roma Statuario
Roma Filo Statuario
Floor
Roma Statuario Lux

LA SUPERFICIE DECORA SURFACES FOR DECORATION

*Tridimensionale nella struttura Filo, o elegante fondo, è sempre la materia la vera decorazione.
Whether it is the three dimensional texture of Filo or the elegant tile, the real decoration is always the material.*



C'EST LA MATIERE QUI DECORE. Tridimensionnel dans sa structure Filo, ou élégante base unie, c'est la matière qui constitue la véritable décoration. / DIE OBERFLÄCHE DEKORIERT. Das 3D- Dekor Filo oder eine elegante Grundfliese, die Dekoration liegt immer in der Materie. / LA SUPERFICIE DECORA. Tridimensional en la estructura Filo, o fondo elegante, la materia resulta ser siempre la auténtica decoración. / ПОВЕРХНОСТЬ УКРАШАЕТ. Объемная структура Filo или элегантная фоновая плитка — в центре внимания неизменно сам материал.



Wall
Roma Statuario
Roma Natura
Statuario Mosaico



*Mosaico Natura,
listello cromato Silver
e il formato del rivesti-
mento 25x75 rendono
tutto contemporaneo.*

*Natura Mosaic, Silver
chrome listel and the
25x75 wall covering
shape make everything
look contemporary.*

Mosaïque Natura, listel chromé Silver et format 25x75 au mur, une association qui apporte à l'espace une réelle touche de modernité. / Mosaik Natura, die verchromte Leiste Silver und die Wandverkleidung im Format 25x75 lassen alles zeitgemäß erscheinen. / Mosaico Natura, listello cromato Silver y el formato del revestimiento 25x75 confieren siempre modernidad. / Мозаика Natura, хромированный бордюр Silver и формат настенной плитки 25x75 преобразуют помещение в современном стиле.



THE RESTAURANT

Il fascino intramontabile dell'esagono interpretato anche nella raffinata versione Decò.

The timeless appeal of the hexagon is also interpreted in the sophisticated Decò version.



Le charme indémodable de la forme hexagonale décliné dans l'élégante version Decò. / Der unvergängliche Charme des Sechseckformats, interpretiert in der raffinierten Version Decò. / La atracción imperecedera del hexágono interpretada también en la refinada versión Decò. / Непревзойденное очарование шестиугольника в утонченной версии Decò.



Stair
Roma Statuario

Floor
Roma Grafite

UNA MATERIA SENZA TEMPO

A TIMELESS MATERIAL

Una gamma completa di pezzi speciali per coordinare perfettamente ogni ambiente della casa. Pavimento, scalino e battiscopa.

A full range of trim tiles to coordinate all the spaces in the home to perfection. Flooring, step and skirting tiles.

UNE MATIÈRE INTEMPORELLE. Un programme complet de pièces spéciales pour revêtir à la perfection chaque espace de la maison. Sol, marche et plinthe. / EINE ZEITLOSE MATERIE. Eine vollständige Auswahl von Spezialteile für eine perfekte Raumkoordination Ihres Heims. Fußboden, Stufe und Fußleiste. / UNA MATERIA A TEMPORAL. Una gama completa de piezas especiales para coordinar a la perfección cada ambiente de la vivienda. Pavimento, escalera y zócalo. / НЕПРЕХОДЯЩАЯ МАТЕРИЯ. Идеальное завершение всех помещений вашего дома благодаря полной гамме специальных элементов. Напольная плитка, ступенька и плинтус.



Floor
Roma Ottagono Statuario
Roma Tozzetto Grafite



Wall
Roma Statuario
Roma Brick Grafite Mosaico

Floor
Roma Grafite



Molteplici formati, creati con la stessa materia, si uniscono per comporre un personale progetto di stile.

A variety of shapes created with the same material and combined to create a personal style project.



Une multitude de formats, tous composés de la même matière, s'unissent pour composer un projet de style personnel. / Eine Vielfalt an Formate erzeugt aus derselben Materie vereinen sich und formen ein stilvolles und persönliches Projekt. / Múltiples formatos, creados con la misma materia, se amalgaman para componer un personal proyecto de estilo. / Многочисленные форматы, созданные из одинакового материала, соединяются в едином проекте, передающем индивидуальный стиль.



ROUND MARBLE



Wall
Roma Statuario
Floor
Roma Righe Statuario Grafite Matt

SHOP SIMPLY CHIC

*Una grande bellezza per realizzare spazi commerciali contemporanei.
Il vero lusso: personalizzarli con sofisticate decorazioni.*

*True beauty for contemporary commercial applications.
True luxury: customisation with sophisticated decorations.*



Le maximum de l'esthétique pour réaliser des espaces commerciaux contemporains. Et pour encore plus de classe, apportez leur une touche de personnalité avec quelques décors. / Eine wunderbare Schönheit für die Erschaffung von zeitgemäßen kommerziellen Räumlichkeiten. Der wahre Luxus: Personalisierung mit raffinierten Dekorationen. / Una gran belleza para realizar espacios comerciales contemporáneos. El auténtico lujo: personalizarlos con sofisticadas decoraciones. / Красота стиля для реализации современных деловых помещений. Придание индивидуальности благодаря изысканным декорам — это настоящая роскошь.





*Essenziale e raffinato
il bianco e nero,
ricercati e cesellati i
decori Tracce e Decò.*

*Essential and elegant
black and white, the
sought-after chiselled
Tracce and Decò
decorations.*

Wall
Roma Statuario
Roma Grafite
Roma Decò Statuario Grafite
Roma Tracce
Floor
Roma Grafite

Le noir et le blanc: essentiel et toujours très raffiné, comme le sont également les décors ciselés Tracce et Decò. / Essentiell und raffiniert das Weiß und Schwarz, ausgesuchte und kunstvoll ausgearbeitete Dekorationen Tracce und Decò. / Esencial y elegante el blanco y negro, minuciosas decoraciones cinceladas Tracce y Decò. / Строгое и утонченное черно-белое решение, изысканные и четкие декоры Трассе и Деко.

GRAFITE

elegante e profondo / elegant and profound

élégant et profond
Elegant und tief
elegante y profundo
элегантная и глубокая

GRES PORCELLANATO
PORCELAIN STONEWARE



80 x 160 RT

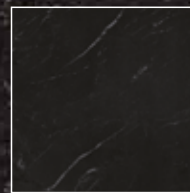

80 x 80 RT

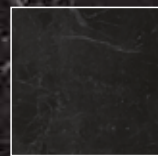

60 x 60 RT

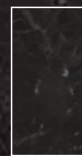

30 x 60 RT

ATELIER



21,6 x 25



20 x 20



7,5 x 30

HOME

*Greca Mosaico e 20x20 senza tempo nell'ingresso. 80x160 una soluzione di continuità in cucina.
Mosaic border and the timeless 20x20 in the entrance hall. 80x160 a seamless solution in the kitchen.*



Greca mosaico et 20x20, de grands classiques indémodables dans l'entrée; 80x160 en contraste dans la cuisine. / Greca Mosaico und 20x20 zeitlos im Vorraum. 80x160 als Kontinuitätslösung in der Küche. / Greca Mosaico y 20x20 atemporal en la entrada. 80x160 Una solución de continuidad en la cocina. / Коридор выложен неувядающей Мозаикой Greca и плиткой формата 20x20. Формат 80x160— решение в едином стиле для кухни.



RELAXING



SHOPPING

ELEGANT CONTEMPORARY

*La seduzione del marmo e
l'affidabilità del gres porcel-
lanato: partner perfetti per
locali esclusivi.*

*The seduction of marble and
the reliability of porcelain
stoneware: ideal partners for
exclusive spaces.*

Wall

Roma Statuario

Floor

Roma Grafite Lux

La séduction
du marbre et
la fiabilité du
grès cérame :
des partenaires
parfaits pour
des espaces
exclusifs. /
Die Verführung
des Marmors
und die Zuver-
lässigkeit des
Feinsteinzeugs:
Perfekte Partner
für exklusive
Räume. /
La seducción
del mármol y
la fiabilidad del
gres porcelá-
nico: excelente
combinación
para locales
exclusivos. /
Очарование
мрамора и
надежность
керамогранита:
идеальное
сочетание для
оформления
эксклюзивных
помещений.



Wall
Roma Grafite
Roma Raku Listello
Floor
Roma Statuario Lux

COOL



TRAVERTINO

ricco e naturale / rich and natural

riche et naturel
Reich und natürlich
rico y natural
роскошная и естественная

PASTA BIANCA
WHITE BODY



25 x 75 25 x 75

GRES PORCELLANATO
PORCELAIN STONEWARE



80 x 160 RT 80 x 80 RT 60 x 60 RT 30 x 60 RT



Wall
Roma Travertino
Roma Filo Travertino
Roma Natura Travertino Mosaico

Floor
Roma Travertino Matt

FASCINO NATURALE NATURAL ATTRACTION

Naturali striature circondano lo spazio. Nella doccia, il mosaico Natura e la versatile materia esprimono soluzioni architettoniche affascinanti.

Natural veins encasing the space. In the shower, the Natura mosaic and the versatile material express attractive architectural solutions.



CHARME NATUREL. Les striures naturelles présentes entourent l'espace. Dans la douche, la mosaïque Natura et la matière très éclectique donnent naissance à des solutions architectoniques particulièrement intéressantes. / NATÜRLICHER CHARME. Natürliche Verläufe umgeben den Raum. In der Dusche strahlen das Mosaik Natura und die vielseitige Materie charmante architektonische Lösungen aus. / ATTRACTIVO NATURAL. Vetas naturales rodean el espacio. En la ducha, el mosaico Natura y la versátil materia muestran excelentes soluciones arquitectónicas. / ОЧАРОВАНИЕ ПРИРОДЫ. Естественное рифление наполняет пространство. В душевой кабине мозаика Natura и многофункциональная керамика воплощают восхитительные архитектурные решения.



GLAM GYM

*Atmosfera sofisticata,
sensazioni naturali.*

*Sophisticated atmosphere,
natural sensations.*

Wall
Roma Travertino

Floor
Roma Travertino

Une atmosphère captivante,
des sensations naturelles. /
Raffinierte Atmosphäre, natür-
liche Sensationen. / Atmós-
fera sofisticada, sensaciones
naturales. / Утонченная
атмосфера, соприкосновение с
природой.

PIETRA

raffinata e accogliente / elegant and inviting

raffinée et accueillante
Raffiniert und einladend
refinada y acogedora
изысканная и уютная

PASTA BIANCA
WHITE BODY



50x120 RT



50x120 RT



25x75



25x75

GRES PORCELLANATO
PORCELAIN STONEWARE



80x160 RT



80x80 RT



60x60 RT



30x60 RT



Wall
Roma Pietra
Roma Filo Pietra
Roma Pietra Mosaico

Floor
Roma Pietra Matt



Differenti e morbide vibrazioni di luce decorano la materia in un mood perfettamente coordinato.

The soft and changing shimmering light decorates the material with a mood that is perfectly coordinated.



Des reflets de lumière, doux et ondoyants, animent cet espace ou tout apparait coordonné avec juste équilibre. / Verschiedene und sanfte Vibrationen von Licht schmücken die Materie in einem perfekt koordinierten Mood. / Distintas vibraciones suaves de luz decoran la materia con un estilo perfectamente coordinado. / Разнообразные мягкие световые блики придают плитке безупречное единство стиля.



Wall
Roma Pietra
Roma Classic Pietra
Roma Classic Pietra Listello
Floor
Roma Pietra Matt

NEW CLASSIC



L'eleganza tridimensionale del decoro Classic sul calore screziato della Pietra: un nuovo classico che sorprende per contemporaneità.

The three dimensional elegance of the Classic decoration on the grainy warmth of Pietra: a new classic whose contemporary mood is astonishing.

L'élégance et le chic du relief du décor Classic en opposition à l'ardeur jaspée de Pietra : un classique insolite qui surprend par sa modernité. / Die 3D-Eleganz des Dekors Classic auf dem natürlichen Farbverlaufs des Pietra: ein neuer Klassiker, der mit seinem modernen Einklang überrascht. / La elegancia tridimensional de la decoración Classic en el cálido vetado de la Pietra: un nuevo clásico que sorprende por su modernidad. / Элегантность трехмерного декора Classic выражена теплыми крапинками Pietra: новая классика, поражающая своей современностью.

Pietra e Imperiale, un abbinamento sofisticato, esaltato dalle infinite possibilità progettuali di Roma.

Pietra and Imperiale a sophisticated combination emphasised by the infinite design possibilities of Roma.



Wall
Roma Pietra
Roma Imperiale
Roma Natura Imperiale Mosaico

Floor
Roma Imperiale Lux



Pietra et Imperiale, un mariage recherché, relevé par les innombrables possibilités conceptuelles de Roma. / Pietra und Imperiale, eine raffinierte Kombination mit unendlichen Planungsmöglichkeiten von Roma. / Pietra e Imperiale, una sofisticada combinación exaltada por infinitas posibilidades proyectuales de Roma. / Pietra и Imperiale, утонченное сочетание, подчеркнутое бесконечными дизайнерскими возможностями Roma.

IMPERIALE

s sofisticato e singolare / sophisticated and unusual

sophisticé et singulier
Raffiniert und einmalig
sofisticado y singular
утонченна и уникальная

PASTA BIANCA
WHITE BODY



50x120 RT



50x120 RT



25x75



25x75

GRES PORCELLANATO
PORCELAIN STONEWARE



80x160 RT



80x80 RT



60x60 RT



30x60 RT

ATELIER



21.6x25



20x20



7.5x30



Wall
Roma Imperiale
Roma Filo Pietra
Floor
Roma Imperiale Lux



ITALIAN BEAUTY

Gli Esagoni evocano una raffinata e attuale memoria del tempo. Affascinanti e funzionali i mattoncini nella zona cottura.

Hexagons conjure up an elegant and contemporary recollection of times gone by. Attractive and practical brick shapes in the hob area.



Les hexagones rappellent le passé, tout en apparaissant très fins et très actuels. Les briquettes de la paroi anti-éclaboussures associent fonctionnalité et recherche esthétique. / Sechseckform für eine raffinierte und aktuelle Erinnerung der Zeit. Faszinierende und funktionelle Fliesen in der Kochzone. / Los Hexágonos evocan una percepción actual y elegante del pasado. Magníficos y funcionales los ladrillos de la zona cocción. / Шестиугольники создают утонченную атмосферу прошлого. Рабочая зона кухни выложена замечательными функциональными кирпичиками.

Wall
Roma Calacatta
Floor
Roma Imperiale



Una preziosa scacchiera realizzata con un sofisticato abbinamento, Imperiale e Calacatta.

A gorgeous chequerboard pattern made using the sophisticated combination of Imperiale and Calacatta.



Ce damier dégage un charme irrésistible par cette association entre Imperiale et Calacatta. / Ein wertvolles Schachbrettmuster, welches anhand eine raffinierte Zusammensetzung realisiert ist. Imperiale und Calacatta. / Un precioso tablero hecho con una sofisticada combinación, Imperiale y Calacatta. / Роскошная шахматная доска выполнена из изящного сочетания плиток Imperiale и Calacatta.

WELCOME STYLE

*Roma, la collezione perfetta per donare alla vostra accoglienza lo stile desiderato.
Roma, the ideal collection to welcome your guests in perfect style.*



Roma, la toile de fond idéale pour recevoir vos amis dans un cadre d'un grand style. / Roma, die perfekte Kollektion die Ihrem Empfang und Begrüßung den gewünschten Stil verleiht. / Roma, la colección perfecta para otorgarle a su recibimiento el estilo deseado. / Roma, идеальная коллекция для придания вашему гостеприимству индивидуального стиля

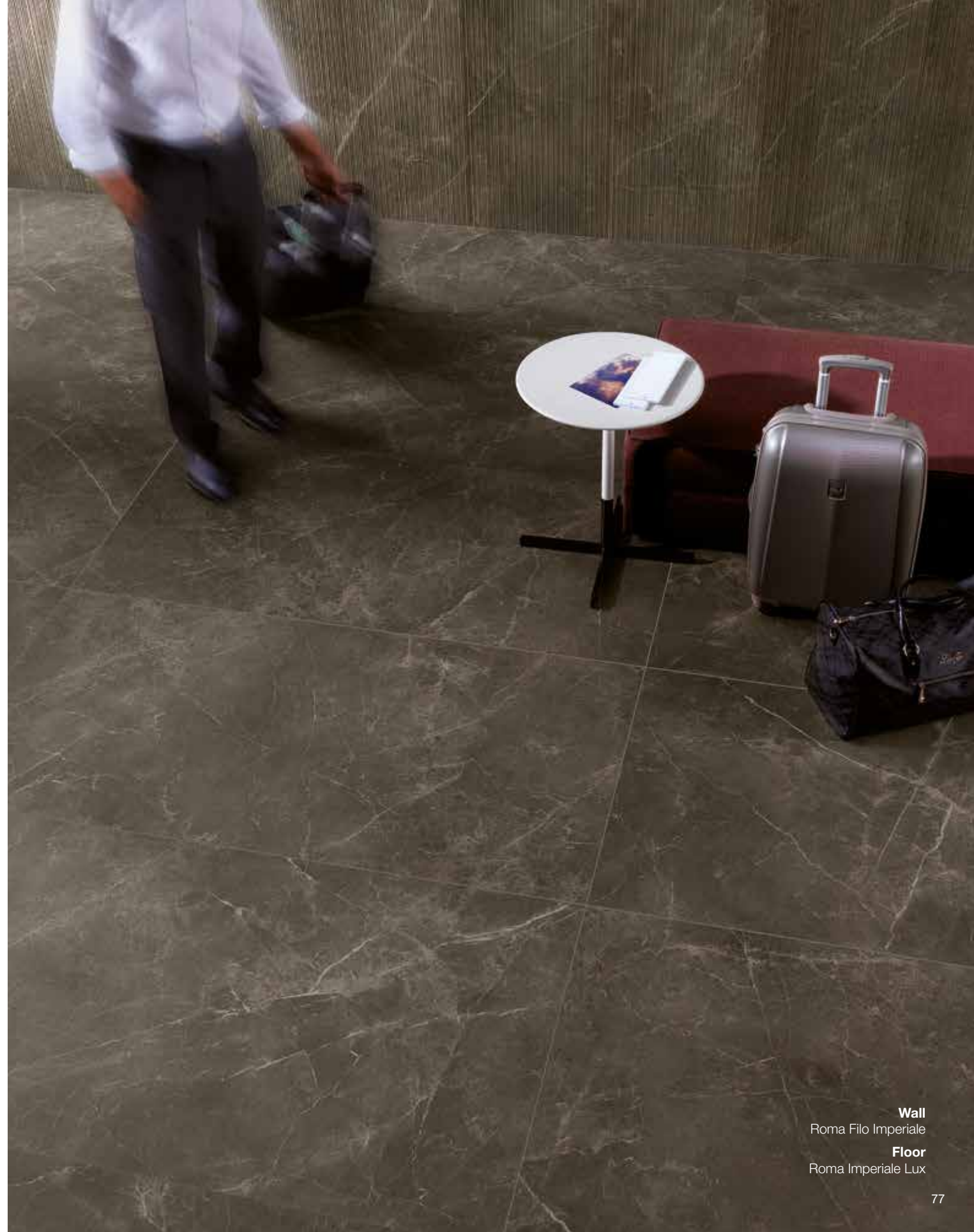

Wall
Roma Filo Imperiale
Floor
Roma Imperiale Lux



Wall
Roma Imperiale
Roma Filo Imperiale
Floor
Roma Imperiale Matt

BELLEZZA AVVOLGENTE ENVELOPING BEAUTY

*Ogni lastra è un pezzo unico.
Una naturale meraviglia fatta di
differenti e spontanee venature.*

*Each slab is unique. A natural
wonder made up of different and
spontaneous veins.*



UNE BEAUTÉ CAPTIVANTE. Chaque plaque est une pièce unique. Une merveille naturelle faite de veinures variées et spontanées. / MITREISSENDE SCHÖNHEIT. Jede Platte ist einzigartig. Ein natürliches Wunder, welches aus unterschiedlichen Verläufe besteh. / ENCANTADORA BELLEZA. Cada losa es una pieza única. Una maravilla natural hecha con diferentes y espontáneas vetas. / ЧАРЮЩАЯ КРАСОТА. Каждая плитка — это уникальный элемент, будто созданный самой природой из неодинаковых произвольных прожилок.

La materia è qui protagonista come decorativo drappeggio e come elemento essenziale per un perfetto piano lavabo.

Here the material is in the spotlight in decorative folds and an essential element for a perfect top for a washbasin.



La matière joue ici un rôle de drapé décoratif et d'élément essentiel, pour un plan de toilette parfait. / Die Materie, Hauptdarsteller als dekorativer Vorhang und als essentielles Element für ein perfektes Waschbecken. / La materia es aquí protagonista como decoración drapeada y elemento esencial para una perfecta encimera de lavabo. / Материя выступает здесь и как роскошная драпировка, и как основной элемент в оформлении зоны раковины.

CALACATTA

caldo e pregiato / warm and precious

prestigieux et chaleureux
Warm und wertvoll
cálido y precioso
Теплая и драгоценная

PASTA BIANCA
WHITE BODY



50 x 120 RT

50 x 120 RT

25 x 75

25 x 75

25 x 75

GRES PORCELLANATO
PORCELAIN STONEWARE



80 x 160 RT

80 x 80 RT

60 x 60 RT

30 x 60 RT

ATELIER



21,6 x 25

20 x 20

7,5 x 30



Wall
Roma Calacatta

Floor
Roma Calacatta Lux

RAFFINATO CALORE ELEGANT WARMTH

*80x160 Lux, la meraviglia del marmo,
la praticità del Gres porcellanato.*

*80x160 Lux, the wonder of marble,
the practical features of porcelain stoneware.*

UNE CHALEUR ENVELOPPANTE.
80x160 Lux, le charme du marbre, les
qualités pratiques du grès cérame. /
RAFFINIERTE WÄRME. 80x160 Lux,
wunderbarer Marmor und prakti-
sches Feinsteinzeug. / REFINADO
CALOR. 80x160 Lux, la maravilla del
mármol, la practicidad del Gres por-
celánico. / ИЗЫСКАННОЕ ТЕПЛО.
80x160 Lux - красота мрамора,
практичность керамогранита.



Wall
Roma Calacatta

Floor
Roma Calacatta Micromosaico

Raffinato e decò: Roma possiede tutti gli elementi decorativi necessari per realizzare lo stile che desideri.

Elegant and decò: Roma has all the decorative elements you need to create the style you want.



Wall

Roma Calacatta Alzata
Roma Fold Calacatta
Roma Calacatta Matita
Roma Greca Calacatta Listello
Roma Calacatta
Roma Calacatta London

Floor

Roma Calacatta

Raffiné et decò : Roma possède tous les éléments décoratifs nécessaires aux recherches de style les plus exigeantes. / Raffiniert und decò: Roma besitzt sämtliche dekorative Elemente für die Realisierung des gewünschten Stils. / Refinada y decò: Roma posee todos los elementos decorativos necesarios para realizar el estilo deseado. / Изысканность и decò : плитка Roma включает все декоративные элементы, необходимые для воплощения вашего персонального стиля.





Wall
Roma Calacatta
Roma Filo Calacatta



VERI INTARSI REAL INTARSIA

*Dalla materia incisa emergono
delicate decorazioni.*

*Delicate decorations emerge
from the engraved material.*

DE VÉRITABLES MARQUETÉRIES.
De la matière incisée naissent
d'élégants décors. / ECHTE IN-
TARSIEN. Die eingravierte Materie
lässt zarte Dekorationen entstehen.
/ AUTÉNTICOS INSERTOS. De la
materia incisa emergen delicadas
decoraciones. / НАСТОЯЩАЯ
ГРАВИРОВКА. Гравированная
плитка превращается в истинное
украшение.



Inspiration rétro et expression contemporaine: une élégance indémodable. / Inspiration retrò in moderner Ausführung: immer elegant. / Inspiración retro en clave moderna, por siempre elegante. / Неувядающее ретро в современном ключе — непревзойденная элегантность.

FOREVER ELEGANT

Ispirazione retrò in chiave contemporanea: per sempre elegante.

A retro look with a contemporary mood: forever elegant.



Wall

Roma Calacatta Alzata
Roma Calacatta
Roma Calacatta Mafita
Roma Calacatta London

Floor

Roma Decò Calacatta Imperiale

SIAMO CERAMICA

UNA SCELTA CONSAPEVOLE

WE ARE CERAMICS

A MINDFUL CHOICE

SICURA PER LA SALUTE

A differenza di altri materiali non contiene plastica, amianto e formaldeide e non rilascia nell'ambiente sostanze organiche pericolose.

IL MASSIMO DELL'IGIENE

Facile da pulire, non assorbe, non si macchia e resiste ai detergenti più aggressivi.

NON BRUCIA

La ceramica è in classe A1 di reazione al fuoco: non si infiamma e in caso di incendio non produce gas e fumi tossici.

SAFE FOR HEALTH

Unlike other materials, it does not contain plastic, asbestos and formaldehyde and does not emit hazardous organic substances into the environment.

MAXIMUM HYGIENE

Easy to clean, non-absorbent, stainproof and resistant to aggressive detergents.

DOES NOT BURN

Ceramic has a Class A1 reaction to fire: it does not ignite and in case of fire, does not give off smoke or toxic gases.

RESISTE A TUTTO

Non si usura per il calpestio, non si graffia, non si ammacca e il colore non si altera nemmeno se esposta ai raggi solari.

VERSATILE

Il design, le superfici, i formati della ceramica la rendono ideale per rivestire pareti e pavimenti di tutti gli ambienti. È un ottimo conduttore termico, perfetto per il riscaldamento a pavimento.

ECOLOGICA

Il processo di produzione rispetta i più rigorosi standard ambientali dell'Unione Europea.

RESISTANT TO EVERYTHING

Does not wear down under foot traffic, does not scratch, does not stain, it does not dent and the colour does not change even when exposed to the sun's rays.

VERSATILE

The design, surfaces, sizes of ceramic make it ideal for covering wall and floors in virtually any environment. It is an excellent thermal conductor, which makes it an ideal choice for underfloor heating.

ECO-FRIENDLY

The production process complies with the strictest environmental standards of the European Union.

comunicazione realizzata in partnership con:
communication carried out in partnership with:

ceramica info
www.ceramica.info



PASTA BIANCA & ATELIER PEZZI SPECIALI WHITE BODY & ATELIER SPECIAL TRIMS

PIÈCES SPÉCIALES FAÏENCE ET LIGNE ATELIER / WEISSSCHERBIGE FORMTEILE & ATELIER / PIEZAS ESPECIALES
PASTA BLANCA Y ATELIER / СПЕЦИАЛЬНЫЕ ЭЛЕМЕНТЫ ИЗ БЕЛОЙ МАССЫ & ATELIER

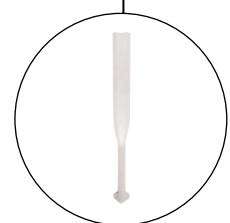

angolo interno
alzata

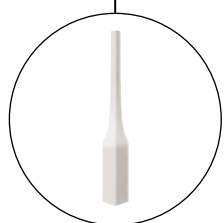

angolo esterno
alzata

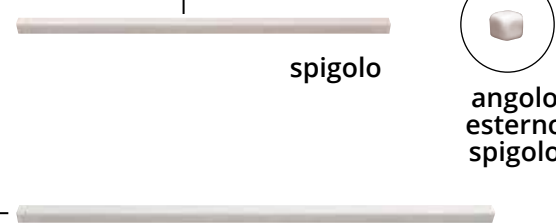

spigolo

angolo
esterno
spigolo

GRES PORCELLANATO PEZZI SPECIALI PORCELAIN STONEWARE SPECIAL TRIMS

PIÈCES SPÉCIALES GRÈS CÉRAME / FEINSTEINZEUG-FORMTEILE / PIEZAS ESPECIALES
GRES PORCELÁNICO / СПЕЦИАЛЬНЫЕ ЭЛЕМЕНТЫ ИЗ КЕРАМОГРАНИТА

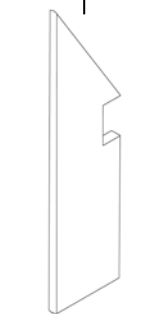

battiscopa
sagomato

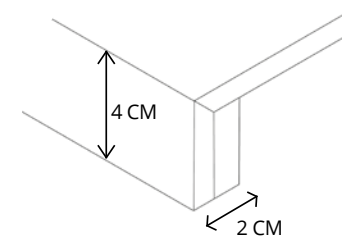

scajno

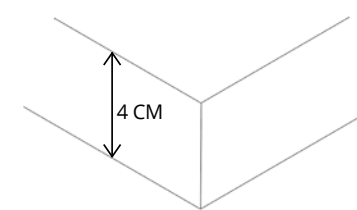

scalino Angolare

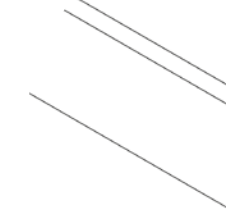

battiscopa

SILK _____



Roma Pietra Silk 120x278 RT V2

SILK _____

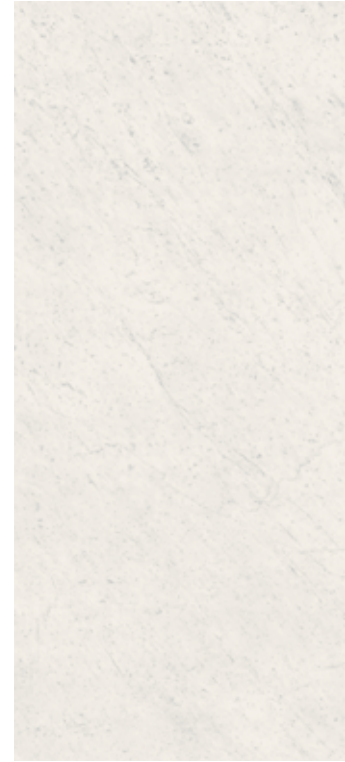

Roma Carrara Silk 120x278 RT V2

SILK _____

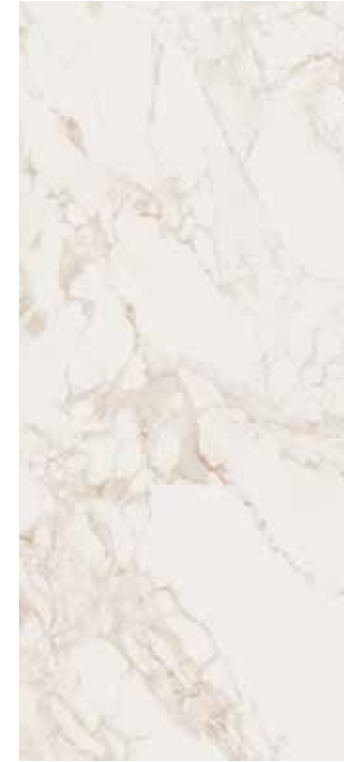

Roma Calacatta Silk 120x278 RT V3



Articolo caratterizzato da grande variabilità delle venature fra le lastre
Article characterized by great variability between the slabs

	Unità di vendita Sales unit	MQ./Box	PZ./Box	Kg/Box	Box/PL
	1 Box	3,336	1	47,94	18



Wall: Roma Diamond Carrara - Floor: Color > Now Grigio Silk



Roma Statuario Lux V3



Roma Grafite Lux V2



Roma Calacatta Lux V3



Roma Pietra Lux V2



Roma Imperiale Lux V2



Roma Travertino Lux V2

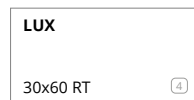
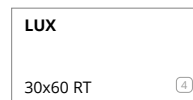
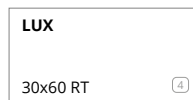
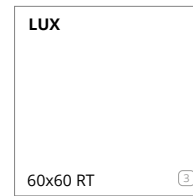
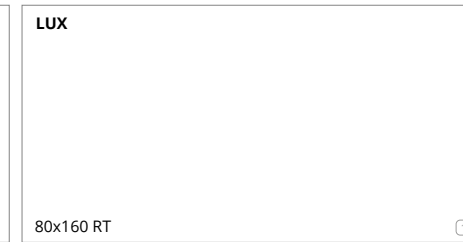
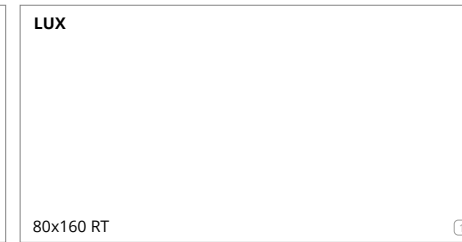
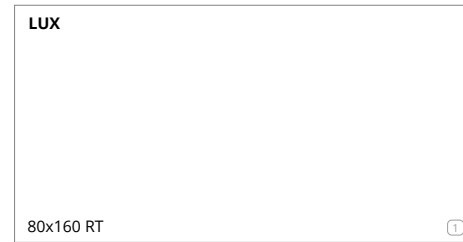
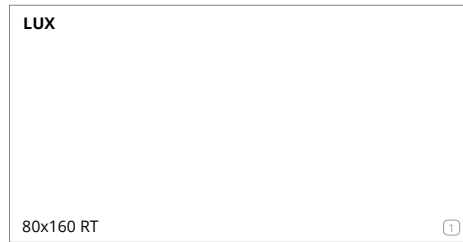
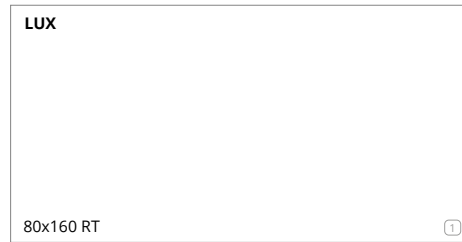
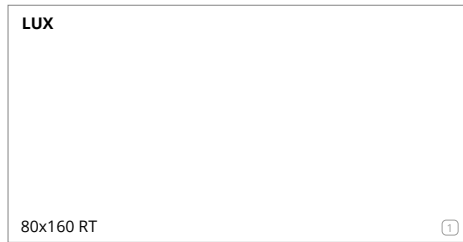

	Unità di vendita Sales unit	MQ./Box	PZ./Box	Kg/Box	Box/PL
①	1 Box	2,560	2	55,12	16
②	1 Box	1,280	2	24,90	48
③	1 Box	1,080	3	23,32	40
④	1 Box	1,260	7	25,00	40



Roma Statuario Matt V3



Roma Grafite Matt V2



Roma Calacatta Matt V3



Roma Pietra Matt V2



Roma Imperiale Matt V2



Roma Travertino Matt V2

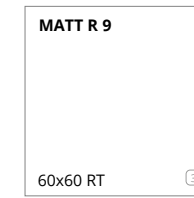
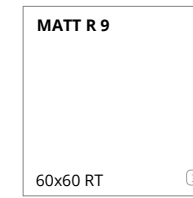
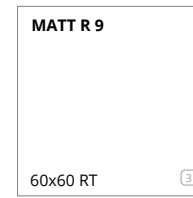
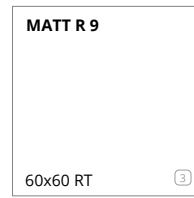
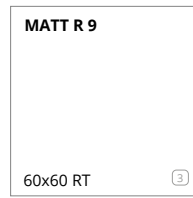
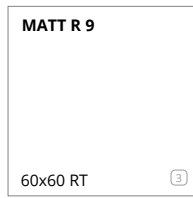
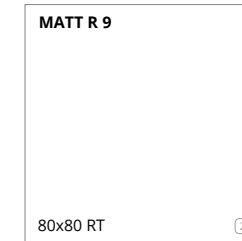
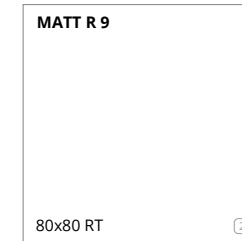
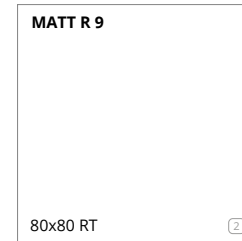
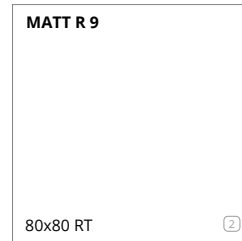
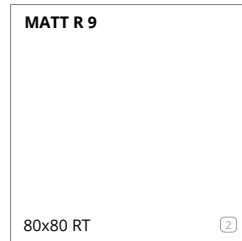
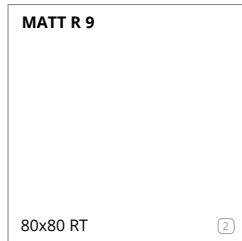
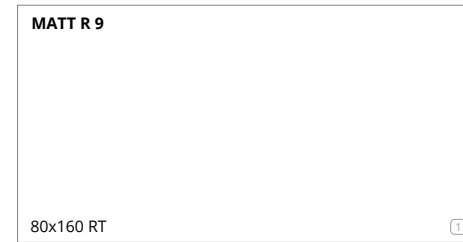
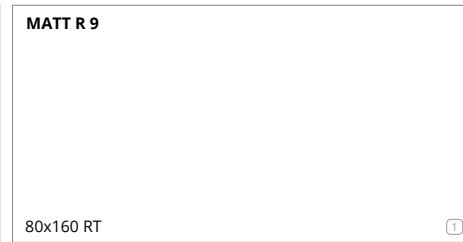
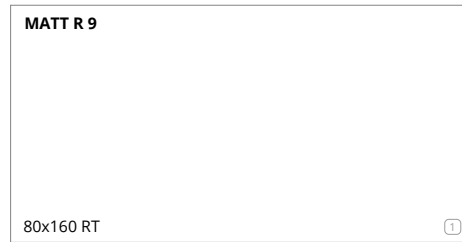
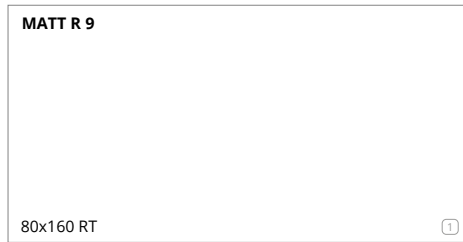

	Unità di vendita Sales unit	MQ./Box	PZ./Box	Kg/Box	Box/PL
①	1 Box	2,560	2	55,12	16
②	1 Box	1,280	2	24,90	48
③	1 Box	1,080	3	24,82	40
④	1 Box	1,260	7	25,00	40

Classification UPEC
Seul le site du CSTB fait foi, pour vérifier les classements indiqués, merci de consulter le site <https://evaluation.cstb.fr/>

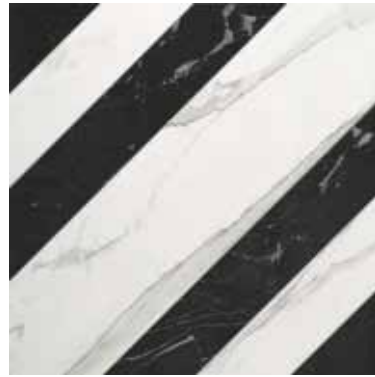

Roma Righe Statuario Grafite Matt Inserto
60x60 RT ①



Roma Righe Calacatta Imperiale Matt Inserto
60x60 RT ①



Roma Righe Matt Inserto



Roma Incroci Statuario Grafite Lux Inserto
60x60 RT ①



Roma Incroci Calacatta Avana Lux Inserto
60x60 RT ①



Roma Incroci Lux Inserto

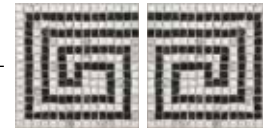

Roma Greca Statuario Grafite
Mosaico Mix 2 20x40 ②

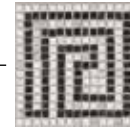

Roma Angolo Greca Statuario Grafite
Mosaico 20x20 ③



MOSAICO



Roma Round Statuario
Mosaico 29,5x32,5*** ④



Roma Round Calacatta
Mosaico 29,5x32,5*** ④



Roma Round Imperiale
Mosaico 29,5x32,5*** ④



Roma Round Travertino
Mosaico 29,5x32,5*** ④



Roma Round Pietra
Mosaico 29,5x32,5*** ④

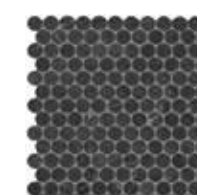

Roma Round Grafite
Mosaico 29,5x32,5*** ④

MOSAICO ANTICATO



Roma Statuario
Macromosaico Anticato 30x30 ⑤

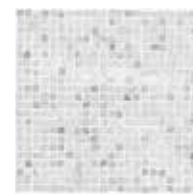

Roma Statuario
Micromosaico Anticato 30x30* ⑤



Roma Brick Statuario
Mosaico Anticato 30x30** ⑤



Roma Calacatta
Macromosaico Anticato 30x30 ⑤



Roma Calacatta
Micromosaico Anticato 30x30* ⑤



Roma Brick Calacatta
Mosaico Anticato 30x30** ⑤

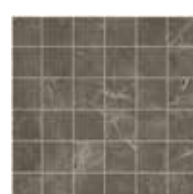

Roma Imperiale
Macromosaico Anticato 30x30 ⑤



Roma Imperiale
Micromosaico Anticato 30x30* ⑤



Roma Brick Imperiale
Mosaico Anticato 30x30** ⑤



Roma Travertino
Macromosaico Anticato 30x30 ⑤



Roma Travertino
Micromosaico Anticato 30x30* ⑤



Roma Brick Travertino
Mosaico Anticato 30x30** ⑤



Roma Pietra
Macromosaico Anticato 30x30 ⑤



Roma Pietra
Micromosaico Anticato 30x30* ⑤



Roma Brick Pietra
Mosaico Anticato 30x30** ⑤

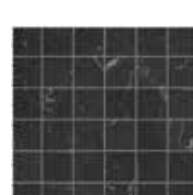

Roma Grafite
Macromosaico Anticato 30x30 ⑤

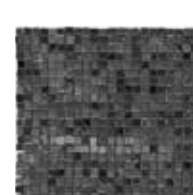

Roma Grafite
Micromosaico Anticato 30x30* ⑤



Roma Brick Grafite
Mosaico Anticato 30x30** ⑤



	Unità di vendita Sales unit	MQ./Box	PZ./Box	Kg/Box	Box/PL
①	1 Box	-	1	8,00	-
②	1 Box	-	2 MIX	3,20	-
③	1 Box	0,160	4	3,20	180
④	1 Box	0,575	6	9,90	72
⑤	1 Box	0,540	6	10,20	60

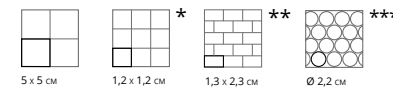



	Unità di vendita Sales unit	MQ./Box	PZ./Box	Kg/Box	Box/PL
①	1 Box	3,75 ML	5	6,02	-
②	1 Box	4,80	8	6,70	-
③	1 Box	-	8	3,55	-
④	1 Box	-	2	-	-

TRIMS

ROMA	STATUARIO	GRAFITE	CALACATTA	PIETRA	IMPERIALE	TRAVERTINO
 Battiscopa 7,2x80 RT 3"x31 ^{1/2} "	 Matt Lux ①	 Matt Lux ①	 Matt Lux ①	 Matt Lux ①	 Matt Lux ①	 Matt Lux ①
 Battiscopa 7,2x60 RT 3"x23 ^{5/8} "	 Matt Lux ②	 Matt Lux ②	 Matt Lux ②	 Matt Lux ②	 Matt Lux ②	 Matt Lux ②
 Battiscopa Sagomato DX 7,2x30 RT 3"x11 ^{3/4} "	 Matt Lux ③	 Matt Lux ③	 Matt Lux ③	 Matt Lux ③	 Matt Lux ③	 Matt Lux ③
 Battiscopa Sagomato SX 7,2x30 RT 3"x11 ^{3/4} "	 Matt Lux ③	 Matt Lux ③	 Matt Lux ③	 Matt Lux ③	 Matt Lux ③	 Matt Lux ③
 Scalino 33x160 RT 13"x63"	 Matt ④	 Matt ④	 Matt ④	 Matt ④	 Matt ④	 Matt ④
 Scalino 33x60 RT 13"x23 ^{5/8} "	 Matt ④	 Matt ④	 Matt ④	 Matt ④	 Matt ④	 Matt ④
 Scalino Angolare 33x33 RT 13"x13"	 Matt ④	 Matt ④	 Matt ④	 Matt ④	 Matt ④	 Matt ④





Roma Statuario 7,5x30 V3



Roma Calacatta 7,5x30 V3



Roma Imperiale 7,5x30 V2

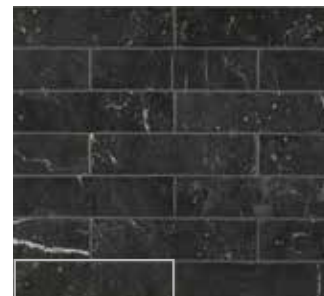

Roma Grafite 7,5x30 V2

MATT

7,5x30

1

MATT

7,5x30

1

MATT

7,5x30

1

MATT

7,5x30

1



Roma Statuario 20x20 V3



Roma Calacatta 20x20 V3



Roma Imperiale 20x20 V2

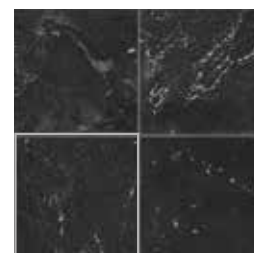

Roma Grafite 20x20 V2

MATT

20x20

2

MATT

20x20

2

MATT

20x20

2

MATT

20x20

2

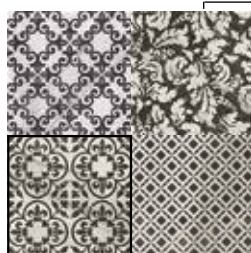

Roma Decò Statuario Grafite 20x20 V3

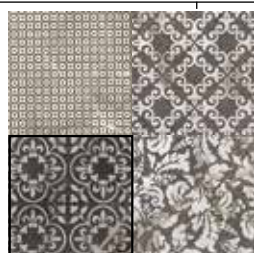

Roma Decò Calacatta Imperiale 20x20 V3

MATT

20x20

2

MATT

20x20

2

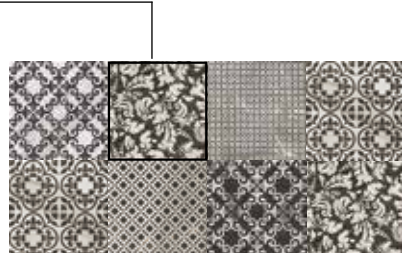

Roma Tracce Statuario Inserto Mix 3 20x60

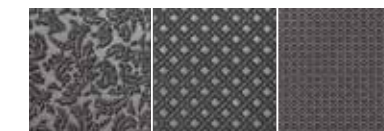

Roma Tracce Grafite Inserto Mix 3 20x60



Roma 30 Statuario London 5,5x30

A.E. London 1,5x5,5

A.I. London 1,5x5,5

Roma 30 Statuario Matita 2x30 RT

A.E. Matita 2x2

Roma 20 Statuario Spigolo 1x20

Roma 7,5 Statuario Spigolo 1x7,5

Roma 20/7,5 Statuario AE Spigolo 1x1



Roma Ottagono Statuario 20x20



Roma 7,5 Statuario Raccordo 2x7,5



Roma 30 Statuario Alzata 17,5x30



Roma 30 Statuario A.E. Alzata 2x17,5



Roma 30 Statuario A.I. Alzata 2x17,5



Roma 30 Calacatta London 5,5x30

A.E. London 1,5x5,5

A.I. London 1,5x5,5

Roma 30 Calacatta Matita 2x30 RT

A.E. Matita 2x2

Roma 20 Calacatta Spigolo 1x20

Roma 7,5 Calacatta Spigolo 1x7,5

Roma 20/7,5 Calacatta AE Spigolo 1x1



Roma Ottagono Grafite 20x20



Roma 7,5 Calacatta Raccordo 2x7,5



Roma 30 Calacatta Alzata 17,5x30



Roma 30 Calacatta A.E. Alzata 2x17,5



Roma 30 Calacatta A.I. Alzata 2x17,5

RomaTozzetto Grafite 5x5

Roma Tozzetto Statuario 5x5

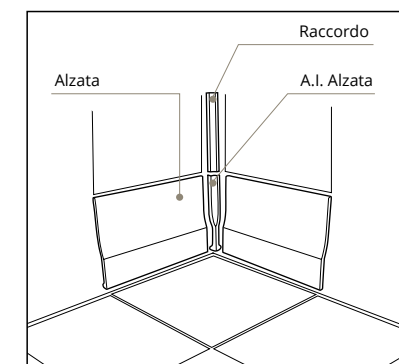
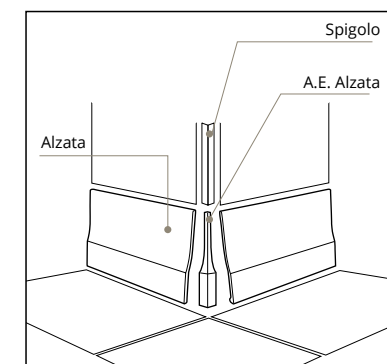

	Unità di vendita Sales unit	MQ./Box	PZ./Box	Kg/Box	Box/PL
1	1 Box	1,08	48	19,50	48
2	1 Box	1,20	30	25,00	56
3	1 Box	-	5	-	-
4	1 Box	-	4	-	-
5	1 Box	-	2 Mix	4,80	-
6	1 Box	0,225	6	5,60	90
7	1 Box	-	6	-	-



Roma Statuario 21,6x25

V3

Roma Calacatta 21,6x25

V3

Roma Imperiale 21,6x25

V2

Roma Grafite 21,6x25

V2

MATT

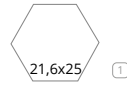

MATT

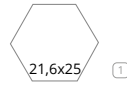

MATT



MATT



Roma Decò Esagono
Statuario Grafite 21,6x25

Roma Decò Esagono
Calacatta Imperiale 21,6x25

MATT

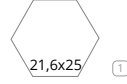

MATT

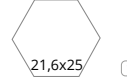

Roma Grafite

	Unità di vendita Sales unit	MQ./Box	PZ./Box	Kg/Box	Box/PL
①	1 Box	1,177	29	23,20	36



fPP8 Roma Statuario 50x120 RT

V3
①



fPQ3 Roma Filo Statuario 50x120 RT

V3
②



fPP5 Roma Calacatta 50x120 RT

V3
①



fPP9 Roma Filo Calacatta 50x120 RT

V3
②



fPP6 Roma Imperiale 50x120 RT

V2
①



fPQ0 Roma Filo Imperiale 50x120 RT

V2
②



fPP7 Roma Pietra 50x120 RT

V2
①



fPQ1 Roma Filo Pietra 50x120 RT

V2
②

AVVERTENZE PER LA POSA IN OPERA DEGLI ARTICOLI FILO: posare il prodotto facendo combaciare i movimenti tridimensionali fra una piastrella e l'altra. Le frecce sul retro non sono indicative del verso di posa.

N.B. FOR ON-SITE LAYING OF THE ITEMS FILO: make sure the three-dimensional patterns of the tiles match. The arrows on the back do not indicate the laying direction.

AVERTISSEMENTS POUR LA POSE DES ARTICLES FILO: poser le produit en faisant coïncider les mouvements tridimensionnels entre un carreau et l'autre. Les flèches situées à l'arrière n'indiquent pas l'orientation de la pose.

HINWEIS FÜR DIE VERLEGUNG DER ARTIKEL FILO: Achten Sie bei der Verlegung darauf, dass die dreidimensionalen Bewegungen zwischen den Fliesen jeweils zusammenpassen. Die Pfeile auf der Rückseite geben keine Hinweise auf die Verlegerichtung.

ADVERTENCIAS PARA LA COLOCACIÓN DE LOS ARTÍCULOS FILO: colocar el producto de manera que coincidan los movimientos tridimensionales entre un azulejo y otro. Las flechas de la parte posterior no indican la dirección de colocación.

ИНСТРУКЦИИ ПО УКЛАДКЕ ПЛИТКИ FILO: расположите плитки таким образом, чтобы трехмерные мотивы на каждой из них соответствовали друг другу. Стрелки на обратной стороне не указывают на направление укладки.

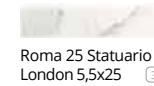

Roma 25 Statuario London 5,5x25 ③

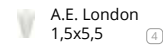

A.E. London 1,5x5,5 ④

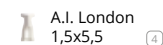

A.I. London 1,5x5,5 ④

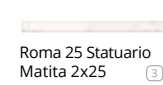

Roma 25 Statuario Matita 2x25 ③

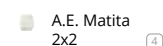

A.E. Matita 2x2 ④

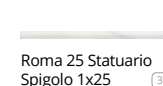

Roma 25 Statuario Spigolo 1x25 ③

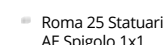

Roma 25 Statuario AE Spigolo 1x1 ④

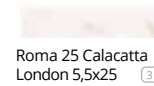

Roma 25 Calacatta London 5,5x25 ③

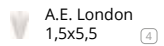

A.E. London 1,5x5,5 ④

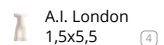

A.I. London 1,5x5,5 ④

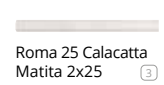

Roma 25 Calacatta Matita 2x25 ③

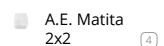

A.E. Matita 2x2 ④



Roma 25 Calacatta Spigolo 1x25 ③

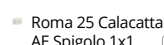

Roma 25 Calacatta AE Spigolo 1x1 ④

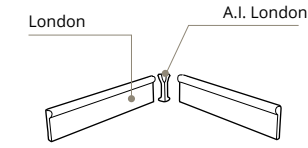
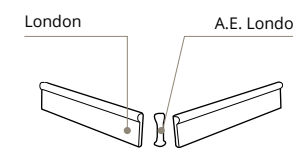

Roma 25 Imperiale Spigolo 1x25 ③

Roma Imperiale AE Spigolo 1x1 ④

Roma 25 Travertino Spigolo 1x25 ③

Roma 25 Travertino AE Spigolo 1x1 ④

Roma 25 Pietra Spigolo 1x25 ③

Roma 25 Pietra AE Spigolo 1x1 ④

	Unità di vendita Sales unit	MQ./Box	PZ./Box	Kg/Box	Box/PL
①	1 Box	1,80	3	31,50	30
②	1 Box	1,80	3	31,80	30
③	1 Box	-	5	-	-
④	1 Box	-	4	-	-



Wall: Roma Calacatta & Fold Calacatta - Floor: Roma Calacatta Micromosaico Anticato



Roma Statuario 25x75

V3
1



Roma Filo Statuario 25x75

V3
2



Roma Fold Statuario 25x75

V3
2



Roma Calacatta 25x75

V3
1



Roma Filo Calacatta 25x75

V3
2



Roma Fold Calacatta 25x75

V3
2



Roma Imperiale 25x75

V2
1



Roma Filo Imperiale 25x75

V2
2



Roma Travertino 25x75

V2
1



Roma Filo Travertino 25x75

V2
2



Roma Pietra 25x75

V2
1



Roma Filo Pietra 25x75

V2
2

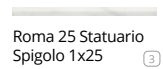

Roma 25 Statuario Spigolo 1x25

3

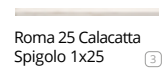

Roma 25 Calacatta Spigolo 1x25

3

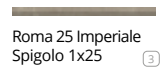

Roma 25 Imperiale Spigolo 1x25

3

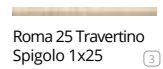

Roma 25 Travertino Spigolo 1x25

3

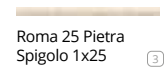

Roma 25 Pietra Spigolo 1x25

3

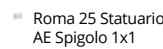

Roma 25 Statuario AE Spigolo 1x1

4

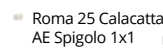

Roma 25 Calacatta AE Spigolo 1x1

4

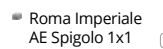

Roma Imperiale AE Spigolo 1x1

4

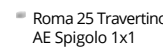

Roma 25 Travertino AE Spigolo 1x1

4

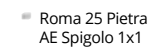

Roma 25 Pietra AE Spigolo 1x1

4

MOSAICO PASTA BIANCA
Spessore 8,5 mm - Thickness 8,5 mm



Roma Statuario Mosaico 30,5x30,5*

5

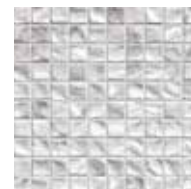

Roma Natura Statuario Mosaico 30,5x30,5**

6



Roma Calacatta Mosaico 30,5x30,5*

5

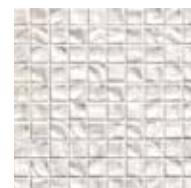

Roma Natura Calacatta Mosaico 30,5x30,5**

6

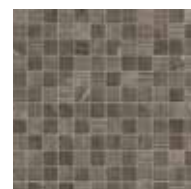

Roma Imperiale Mosaico 30,5x30,5*

5

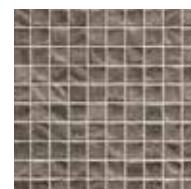

Roma Natura Imperiale Mosaico 30,5x30,5**

6



Roma Travertino Mosaico 30,5x30,5*

5

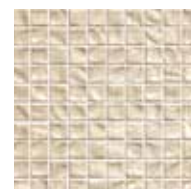

Roma Natura Travertino Mosaico 30,5x30,5**

6



Roma Pietra Mosaico 30,5x30,5*

5



Roma Natura Pietra Mosaico 30,5x30,5**

6



*
2,3 x 2,3 cm



**
2,8 x 2,8 cm

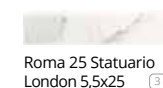

Roma 25 Statuario London 5,5x25

3

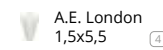

A.E. London 1,5x5,5

4

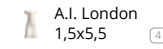

A.I. London 1,5x5,5

4

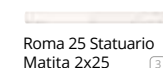

Roma 25 Statuario Matita 2x25

3

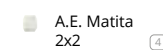

A.E. Matita 2x2

4



Roma 25 Calacatta London 5,5x25

3

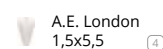

A.E. London 1,5x5,5

4

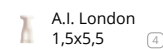

A.I. London 1,5x5,5

4

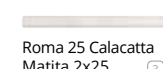

Roma 25 Calacatta Matita 2x25

3

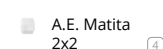

A.E. Matita 2x2

4



Roma 25 Statuario Raccordo 2x25

3



Roma 25 Calacatta Raccordo 2x25

3



Roma 25 Statuario Alzata 17,5x25

4



Roma 25 Calacatta Alzata 17,5x25

4



Roma 25 Statuario A.E. Alzata 2x17,5

3



Roma 25 Calacatta A.E. Alzata 2x17,5

3



Roma 25 Statuario A.I. Alzata 2x17,5

3



Roma 25 Calacatta A.I. Alzata 2x17,5

3

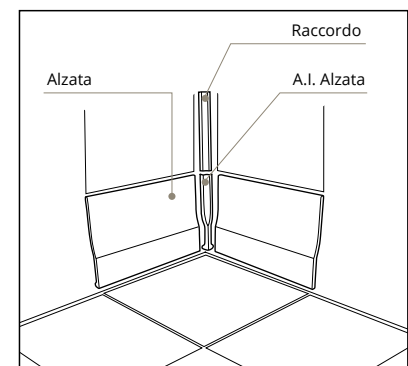
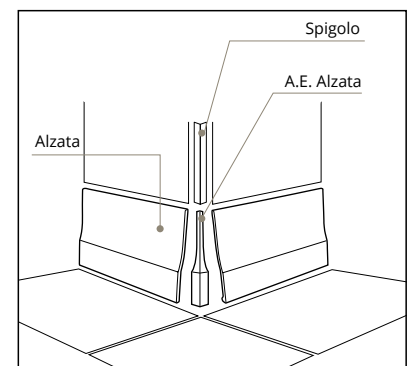
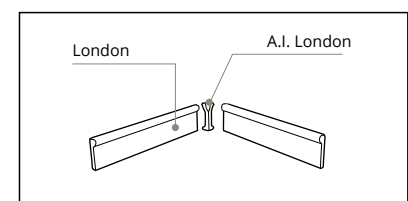
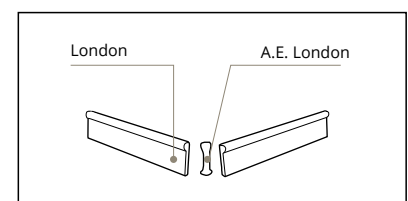

	Unità di vendita Sales unit	MQ./Box	PZ./Box	Kg/Box	Box/PL
1	1 Box	1,125	6	16,80	54
2	1 Box	0,937	5	14,25	54
3	1 Box	-	5	-	-
4	1 Box	-	4	-	-
5	1 Box	0,558	6	8,20	84
6	1 Box	0,558	6	8,20	60

QB WallPEC
3 2
Classification WallPEC
Seul le site du CSTB
fait foi, pour vérifier
les classements
indiqués, merci de
consulter le site
<https://evaluation.cstb.fr/>



Roma Classic Statuario Inserto 25x75 ①



Roma Classic Statuario List. 8x25 ②



Roma Classic Calacatta Inserto 25x75 ①



Roma Classic Calacatta List. 8x25 ②



Roma Classic Pietra Inserto 25x75 ①



Roma Classic Pietra List. 8x25 ②



Roma Fold Glitter Statuario Inserto 25x75 ①



Roma Greca Statuario List. 8x25 ②



Roma Fold Glitter Calacatta Inserto 25x75 ①



Roma Greca Calacatta List. 8x25 ②



Roma Greca Pietra List. 8x25 ②



Roma Raku Listello 6x25 ②



Roma Classic Listello



Roma Raku Listello

	Unità di vendita Sales unit	MQ./Box	PZ./Box	Kg/Box	Box/PL
①	1 Box	-	4	12,10	-
②	1 Box	-	5	1,65	-

SUGGERIMENTI DI POSA ATELIER

7,5x30

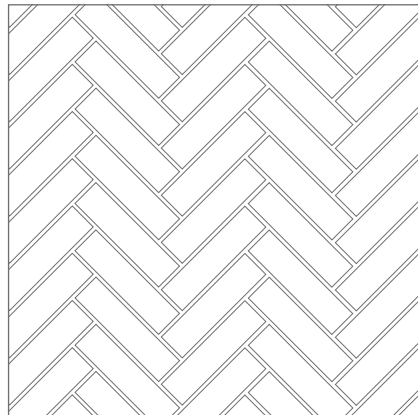
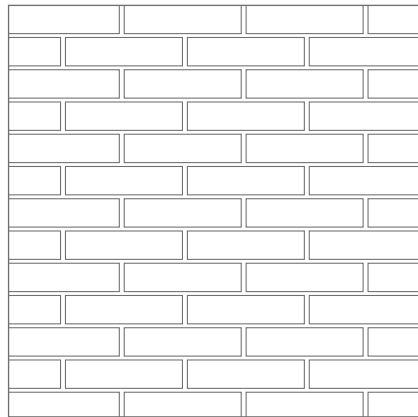

Fuga 3-5 mm / 3-5 mm gap

7,5x45

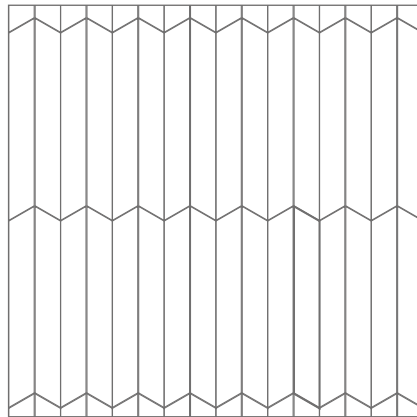
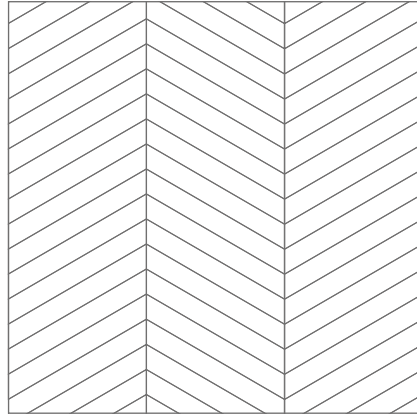

Fuga 3-5 mm / 3-5 mm gap

20x20

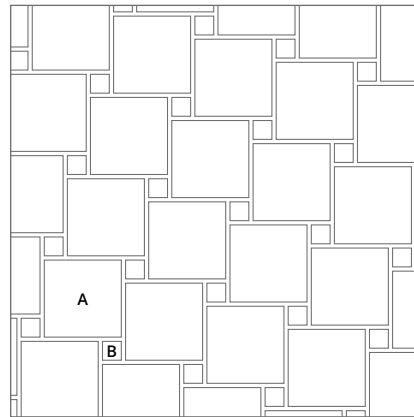
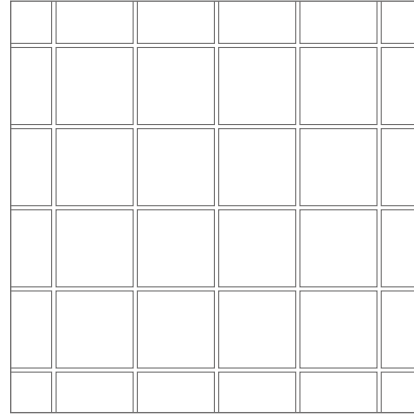

A: 94,1% B: 5,9%

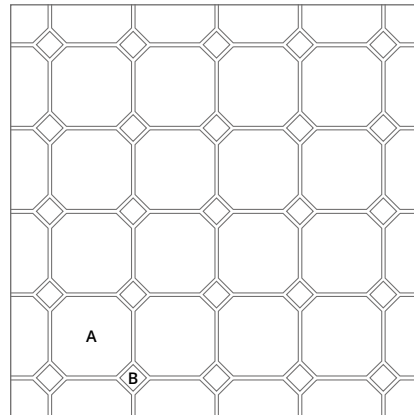

A: 93,75% B: 6,25%

Fuga 2-3 mm / 2-3 mm gap

INSTALLATION TIPS ATELIER

Esagono 21,6x25

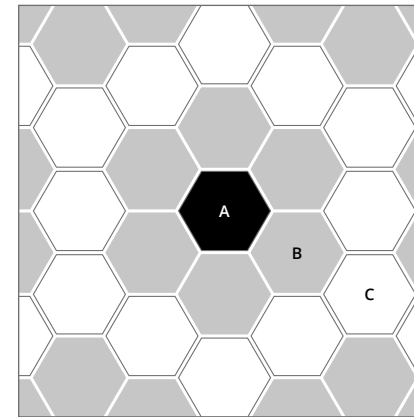
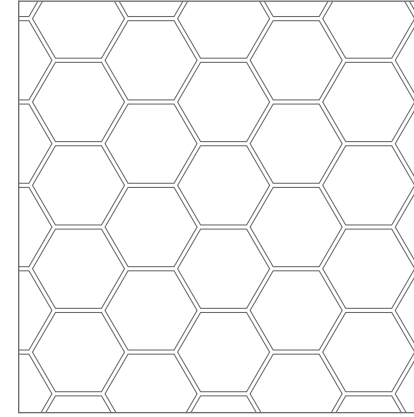

A: 8,33% B: 50% C: 41,67%

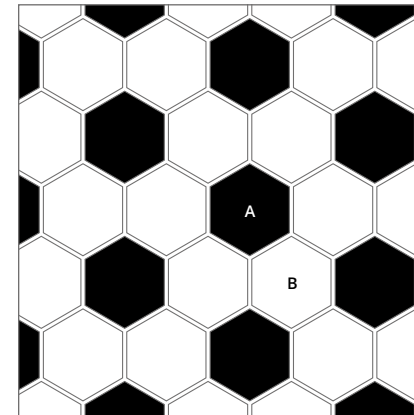



















A: 33,3% B: 66,6%

Fuga 3-5 mm / 3-5 mm gap

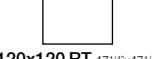
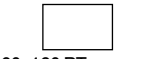

Firenze Nero & Esagono Fiore

ROMA = RM
 ROMA DIAMOND= RD
 ROMA GOLD= RG

			BEIGE DUNA			CALACATTA			CALACATTA DELICATO			CALACATTA ORO			CARRARA			CARRARA SUPERIORE			GRAFITE			GRIGIO SUPERIORE			IMPERIALE			NERO ELEGANTE			NERO REALE			ONICE MIELE			ONICE NEVE			PIETRA			STATUARIO			TRAVERTINO		
			BRILL	LUX	MATT	BRILL	LUX	MATT	BRILL	LUX	MATT	BRILL	LUX	MATT	BRILL	LUX	MATT	BRILL	LUX	MATT	BRILL	LUX	MATT	BRILL	LUX	MATT	BRILL	LUX	MATT	BRILL	LUX	MATT	BRILL	LUX	MATT	BRILL	LUX	MATT	BRILL	LUX	MATT	BRILL	LUX	MATT	BRILL	LUX	MATT	BRILL	LUX	MATT
WALL TILES		50x120 RT 19 ^{5/8} "x47 ^{1/4} "	RD			RD			RM	RG		RG			RD			RG									RM			RG			RG									RM	RD	RM						
		Filo 50x120 RT 19 ^{5/8} "x47 ^{1/4} "							RM																		RM															RM		RM						
		Line 50x120 RT 19 ^{5/8} "x47 ^{1/4} "	RD			RD									RD																														RD					
		30,5x56 RT 12"x22"							RG			RG						RG												RG			RG																	
		25x75 9 ^{7/8} "x29 ^{1/2} "	RD			RD			RM						RD												RM															RM	RD	RM			RM			
		Filo 25x75 9 ^{7/8} "x29 ^{1/2} "							RM																					RM															RM		RM			
		Fold 25x75 9 ^{7/8} "x29 ^{1/2} "							RM																																							RM		
		Line 25x75 9 ^{7/8} "x29 ^{1/2} "	RD			RD									RD																																	RD		
		Diamante 15x56 5 ^{7/8} "x22"							RG			RG						RG												RG			RG																	
GRES PORCELLANATO		120x278 RT 47 ^{1/4} "x109 ^{1/2} "	RD			RD			RM	RG		RG			RD			RM	RG					RD						RG			RG									RM	RD							
		80x160 RT 31 ^{1/2} "x61"	RD			RD	RM	RM	RG			RG			RD			RG				RM	RM	RD				RM	RM	RG		RD		RG						RM	RM	RD	RM	RM	RM	RM	RM			
		120x120 RT 47 ^{1/4} "x47 ^{1/4} "	RD			RD			RG			RG			RD			RG									RD						RG												RD					
		60x120 RT 23 ^{5/8} "x47 ^{1/4} "							RG			RG						RG												RG			RG																	
		80x80 RT 31 ^{1/2} "x31 ^{1/2} "	RD			RD	RM	RM	RG			RG			RD			RG				RM	RM	RD				RM	RM	RG		RD		RG						RM	RM	RD	RM	RM	RM	RM	RM			
		60x60 RT 23 ^{5/8} "x23 ^{5/8} "	RD			RD	RM	RM							RD							RM	RM	RD				RM	RM			RD								RM	RM	RD	RM	RM	RM	RM	RM			
		40x80 RT 15 ^{3/4} "x31 ^{1/2} "							RG			RG						RG												RG																				
		30x60 RT 11 ^{3/4} "x23 ^{5/8} "					RM	RM														RM	RM																			RM	RM		RM	RM				
		7,5x30 RT 3"x11 ^{3/4} "																																														RM		
		20x20 RT 7 ^{7/8} "x7 ^{7/8} "																																														RM		
		21,6x25 RT 8 ^{1/2} "x9 ^{7/8} "																																														RM		

Test

Pasta Bianca - Standard EN 14411 (ISO 13006) Annex L Group BIII, E_v > 10%

White body. / Weißscherbiger. / Pâte blanche. / Pasta blanca. / Белый глины.

CARATTERISTICHE TECNICHE TECHNICAL SPECIFICATIONS CARACTERISTIQUES TECHNIQUES TECHNISCHE EIGENSCHAFTEN CARACTERÍSTICAS TÉCNICAS ТЕХНИЧЕСКИЕ ХАРАКТЕРИСТИКИ			ROMA				
			NON RETTIFICATO - NOT RECTIFIED	RETTIFICATO - RECTIFIED	TUTTI I FORMATI - ALL SIZES		
DIMENSIONI SIZES DIMENSIONS GROSSEN DIMENSIONES РАЗМЕРЫ		Lunghezza e larghezza Length and width / Dimensions des côtés / Seitenlänge / Largo y ancho / Длина и ширина	± 0,6%, max 2 mm	± 0,3%, max 1 mm	Conforme In accordance		
		Spessore Thickness / Epaisseur / Stärke / Espesor / Толщина	± 10%, max 0,5 mm	± 10%, max 0,5 mm	Conforme In accordance		
		Ortogonalità ** Wedging / Orthogonalité / Rechtwinkligkeit / Ortogonalidad / Ортогональность	± 0,5%, max 2 mm	± 0,3%, max 1,5 mm	Conforme In accordance		
		Rettilineità degli spigoli Straightness of the edges / Equerrage des angles / Kantengeradheit / Rectilinearidad de las aristas / Прямолинейность углов	± 0,5%, max 1,5 mm	± 0,3%, max 0,8 mm	Conforme In accordance		
		Planarità Flatness / Planéité / Oberflächenqualität / Planicidad / Плоскостность	± 0,5%, max 2 mm	± 0,4%, max 1,8 mm	Conforme In accordance		
		Aspetto della superficie % senza difetti nel lotto di prova Quality of the surface Faultless % within the sample lot / Qualité de la surface % sans défauts dans le lot d'essai / Oberflächenqualität % an fehlerfreien Fliesen im Prüfbett / Aspecto de la superficie % sin defectos en el lote de prueba / Вид поверхности % без брака в пробной партии	≥ 95%		Conforme In accordance		
STRUTTURA STRUCTURE STRUCTURE STRUKTUR ESTRUCTURA СТРУКТУРА		Assorbimento d'acqua - valore medio % Water absorption - average value % / Absorption d'eau - valeur moyenne % / Wasseraufnahme - Durchschnittswert % / Absorción de agua - valor medio % / Водопоглощение Среднее значение %	ISO 10545-3	> 10%	Conforme In accordance		
			Sforzo di rottura Breaking strength / Force de rupture / Bruchlast / Esfuerzo di ruptura / Усилие на излом	ISO 10545-4	S ≥ 600 N	Conforme In accordance	
			Resistenza alla flessione Bending strength / Résistance à la flexion / Biegefestigkeit / Resistencia a la flexión / Прочность при изгибе		R ≥ 12 N / mm ²	Conforme In accordance	
SBALZI TERMICI THERMAL SHOCK ECARTS DE TEMPERATURE TEMPERATURWECHSEL CHOQUES TÉRMICOS ТЕМПЕРАТУРНЫЕ ПЕРЕПАДЫ		Resistenza agli sbalzi termici Thermal shock resistance / Resistance aux variations thermiques / Temperaturwechselbeständigkeit / Resistencia a las diferencias de temperatura / Сопротивление температурным перепадам	ISO 10545-9	Conforme In accordance	Conforme In accordance		
SUPERFICIE SURFACE SURFACE OBERFLÄCHE SUPERFICIE ПОВЕРХНОСТЬ		Resistenza al cavillo Crazing resistance / Résistance aux craquelures / Haarriß-Beständigkeit / Resistencia al cuarteado / Сопротивляемость образованию кракелюров	ISO 10545-11	Conforme In accordance	Conforme In accordance		
		Resistenza ai prodotti chimici di uso domestico e agli additivi per piscina Resistance to household chemicals and swimming pool salts / Résistance aux produits chimiques à usage domestique et aux adjuvants pour piscines / Beständigkeit gegen Haushaltchemikalien und Badewasserzusätze / Resistencia a los productos químicos de uso domestico o productos para la piscina / Сопротивляемость химическим средствам домашнего применения и добавкам для бассейна.	ISO 10545-13	B Min.	Conforme In accordance		
		Resistenza a basse concentrazioni di acidi ed alcali Resistance to low concentrations of acids and alkalis / Résistance aux acides et aux alcalis à basse concentration / Beständigkeit gegen niedrigkonzentrierte Säuren und Laugen / Resistencia a concentración baja de ácidos y álcali / Сопротивляемость кислотам и щелочам низкой концентрации		Metodo di prova disponibile Test method available / Méthode d'essai disponible / Verfügbare Prüfmethode / Método de prueba disponible / Доступный метод испытания		LB Min.	
		Resistenza alle macchie Stain resistance / Résistance aux taches / Baständigkeit gegen Fleckenbildung / Resistencia a las manchas / Стойкость к загрязнению	ISO 10545-14	MINIMUM CLASS 3		5	

* Valore medio dei test condotti negli ultimi 24 mesi. Average rating of tests conducted during the last 24 months. Durchschnittswert der in den letzten 24 Monaten durchgeführten Tests. Valeur moyenne des essais menés au cours des 24 derniers mois. Valor medio de las pruebas llevadas a cabo en los últimos 24 meses. Среднее значение испытаний, проведенных в течение последних 24 месяцев.

** Per piastrelle rettangolari, che abbiano il lato maggiore L ≥ 60 cm, e rapporto tra i lati ≥ 3, la misurazione della ortogonalità deve venire condotta solo sul lato corto. For oblong tiles with L ≥ 60 cm and ratio length/width L/W ≥ 3, measurement of rectangularity only on short edges

Test

Gres Porcellanato - Standard EN 14411 (ISO 13006) Annex G Group Bla, E_v ≤ 0,5%

Porcelain. / Grès cerame. / Feinsteinzeug. / Gres porcelánico. / Керамогранит.





CARATTERISTICHE TECNICHE TECHNICAL SPECIFICATIONS CARACTERISTIQUES TECHNIQUES TECHNISCHE EIGENSCHAFTEN CARACTERÍSTICAS TÉCNICAS ТЕХНИЧЕСКИЕ ХАРАКТЕРИСТИКИ			ROMA							
			NON RETTIFICATO - NOT RECTIFIED	RETTIFICATO - RECTIFIED	ATELIER	LUX	MATT			
DIMENSIONI SIZES DIMENSIONS GROSSEN DIMENSIONES РАЗМЕРЫ		Lunghezza e larghezza Length and width / Dimensions des côtés / Seitenlänge / Largo y ancho / Длина и ширина	ISO 10545-2	± 0,6%, max 2 mm	± 0,3%, max 1 mm	Conforme In accordance	Conforme In accordance	Conforme In accordance		
		Spessore Thickness / Epaisseur / Stärke / Espesor / Толщина		± 5%, max 0,5 mm	± 5%, max 0,5 mm	Conforme In accordance	Conforme In accordance	Conforme In accordance		
		Ortogonalità ** Wedging / Orthogonalité / Rechtwinkligkeit / Ortogonalidad / Ортогональность		± 0,5%, max 2 mm	± 0,3%, max 1,5 mm	Conforme In accordance	Conforme In accordance	Conforme In accordance		
		Rettilineità degli spigoli Straightness of the edges / Equerrage des angles / Kantengeradheit / Rectilinearidad de las aristas / Прямолинейность углов		± 0,5%, max 1,5 mm	± 0,3%, max 0,8 mm	Conforme In accordance	Conforme In accordance	Conforme In accordance		
		Planarità Flatness / Planéité / Oberflächenqualität / Planicidad / Плоскостность		± 0,5%, max 2 mm	± 0,4%, max 1,8 mm	Conforme In accordance	Conforme In accordance	Conforme In accordance		
STRUTTURA STRUCTURE STRUCTURE STRUKTUR ESTRUCTURA СТРУКТУРА		Assorbimento d'acqua - valore medio % Water absorption - average value % / Absorption d'eau - valeur moyenne % / Wasseraufnahme - Durchschnittswert % / Absorción de agua - valor medio % / Водопоглощение Среднее значение %	ISO 10545-3	≤ 0,5%		Conforme In accordance	Conforme In accordance	Conforme In accordance		
			Sforzo di rottura Breaking strength / Force de rupture / Bruchlast / Esfuerzo di ruptura / Усилие на излом	ISO 10545-4	S ≥ 1300 N			S ≥ 2000 N	S ≥ 2000 N	S ≥ 2000 N
			Resistenza alla flessione Bending strength / Résistance à la flexion / Biegefestigkeit / Resistencia a la flexión / Прочность при изгибе		R ≥ 35 N/mm ²		Conforme In accordance	Conforme In accordance	Conforme In accordance	
			Abrasion profonda Deep abrasion / Abrasion profonde / Tiefenabrieb / Abrasión profunda / Глубокое истирание	ISO 10545-6	≤ 175mm ³			≤ 140mm ³	≤ 140mm ³	≤ 140mm ³
			PEI	ISO 10545-7	Abrasion Class and Cycled Passed			-	-	-
SBALZI TERMICI THERMAL SHOCK ECARTS DE TEMPERATURE TEMPERATURWECHSEL CHOQUES TÉRMICOS ТЕМПЕРАТУРНЫЕ ПЕРЕПАДЫ		Coefficiente di dilatazione termica lineare Coefficient of thermal linear expansion / Coefficient de dilatation thermique linear / Wärmeausdehnungskoeffizient / Coeficiente de dilatación termica linear / Коэффициент теплового линейного расширения	ISO 10545-8	Valore dichiarato Declared Value / Valeur déclarée / Angegebener Wert / Valor declarado / Объявленная ценность		≤ 7 MK ⁻¹	≤ 7 MK ⁻¹	≤ 7 MK ⁻¹		
			Resistenza agli sbalzi termici Thermal shock resistance / Resistance aux variations thermiques / Temperaturwechselbeständigkeit / Resistencia a las diferencias de temperatura / Сопротивление температурным перепадам	ISO 10545-9	Resistente Resistant		Resistente Resistant	Resistente Resistant	Resistente Resistant	
			Resistenza al gelo Resistance to frost / Résistance au gel / Frostbeständigkeit / Resistencia al hielo / Морозоустойчивость	ISO 10545-12	Resistente Resistant		Resistente Resistant	Resistente Resistant	Resistente Resistant	
SICUREZZA SAFETY SÉCURITÉ SICHERHEIT SEGURIDAD БЕЗОПАСНОСТЬ		Coefficiente di attrito dinamico Dynamic friction coefficient / Coefficient de frottement dynamique / Dynamischer Reibungskoeffizient / Coefficiente de fricción dinámico / Динамический коэффициент трения	DCOF BOT 3000	Slip resistant ≥ 0,42		Conforme In accordance	-	Conforme In accordance		
		Coefficiente di attrito dinamico Dynamic friction coefficient / Coefficient de frottement dynamique / Dynamischer Reibungskoeffizient / Coefficiente de fricción dinámico / Динамический коэффициент трения	DIN 51130	In funzione dell'ambiente o della zona di lavoro. According to the space or the working area / Selon le lieu concerné ou la zone de travail / Je nach Raum oder Arbeitszone / Según el ambiente o de la zona de trabajo / В зависимости от среды или рабочей зоны			-	-	R9	
		Classificazione antiscivolo Non-slip classification / Classification antiderapant / Bewertungsgruppe trittsicherheit / Clasificación antideslizante / Классификация противоскольжения	DIN 51097	In funzione delle zone bagnate soggette a calpestio a piedi nudi. According to the wet area to be stepped on barefoot / Selon le type de surface mouillée parcourue pieds nus. / Je nach Nassbereich die barfuß zu betreten sind / Según de la zona mojada que se pisa con los pies desnudos / С учётом увлажняемых зон, предназначенных для ходьбы босиком				-	-	-
RESISTENZA CHIMICA CHEMICAL RESISTANCE RÉSISTANCE AUX ATTAQUES CHIMIQUES CHEMIKALIENFESTIGKEIT RESISTENCIA A LOS PRODUCTOS QUÍMICOS ХИМИЧЕСКАЯ СТОЙКОСТЬ		Resistenza ai prodotti chimici di uso domestico e agli additivi per piscina Resistance to household chemicals and swimming pool salts / Résistance aux produits chimiques à usage domestique et aux adjuvants pour piscines / Beständigkeit gegen Haushaltchemikalien und Badewasserzusätze / Resistencia a los productos químicos de uso domestico o productos para la piscina / Сопротивляемость химическим средствам домашнего применения и добавкам для бассейна.	ISO 10545-13	MINIMUM B		Conforme In accordance	Conforme In accordance	Conforme In accordance		
		Resistenza a basse concentrazioni di acidi ed alcali Resistance to low concentrations of acids and alkalis / Résistance aux acides et aux alcalis à basse concentration / Beständigkeit gegen niedrigkonzentrierte Säuren und Laugen / Resistencia a concentración baja de ácidos y álcali / Сопротивляемость кислотам и щелочам низкой концентрации		Secondo la classificazione indicata dal fabbricante. According to classification indicated by the manufacturer / Second la classification indiquée par le fabricant / Je nach der angegebenen Fabrikantenbewertung / Según la clasificación indicada del fabricante / Согласно классификации, указанной производителем.		LB Min.	LB Min.	LB Min.		
		Resistenza alle macchie Stain resistance / Résistance aux taches / Baständigkeit gegen Fleckenbildung / Resistencia a las manchas / Стойкость к загрязнению	ISO 10545-14	UGL: Metodo di prova disponibile / Test method available / Méthode d'essai disponible / Verfügbare Prüfmethode / Método de prueba disponible / Доступный метод испытания GL: Minimum 3		5	5	5		

* Valore medio dei test condotti negli ultimi 24 mesi. Average rating of tests conducted during the last 24 months. Durchschnittswert der in den letzten 24 Monaten durchgeführten Tests. Valeur moyenne des essais menés au cours des 24 derniers mois. Valor medio de las pruebas llevadas a cabo en los últimos 24 meses. Среднее значение испытаний, проведенных в течение последних 24 месяцев.

** Per piastrelle rettangolari, che abbiano il lato maggiore L ≥ 60 cm, e rapporto tra i lati ≥ 3, la misurazione della ortogonalità deve venire condotta solo sul lato corto. For oblong tiles with L ≥ 60 cm and ratio length/width L/W ≥ 3, measurement of rectangularity only on short edges

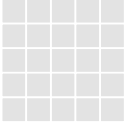
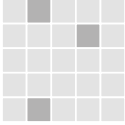
VSHADE

La classificazione V-Shade indica il livello di stonizzazione del prodotto, classificato da V0 a V4.
The V-Shade classification indicates the level of shading of the product, ranked from V0 to V4.

V0	V1	V2	V3	V4
				
Nessuna None Aucune Keine Ninguna нулевой	Leggera Light Légère Leicht Ligera Низкий	Moderata Moderate Modérée Mäßig Moderada Средний	Alta High Élevée Hoch Alta Значительный	Forte Very High Forte Stark Fuerte Высокий

Le classement V-shade indique le niveau de mouvement chromatique au sein d'un produit. Il va de V0 à V4.

Die V-Shade-Einstufung zeigt das Abtönungsniveau des Produkts an, das zwischen V0 und V4 eingestuft wird.

La clasificación V-Shade indica el nivel de destonización del producto, clasificado de V0 a V4.

Согласно классификации V-Shade, указывающей на уровень цветовой неоднородности изделия, нашей плитке были присвоены значения от V0 до V4.

Per tutte le istruzioni di posa, pulizia e smaltimento, consultare il sito www.fapceramiche.com alla sezione Faq.

For full instructions on installation, cleaning and disposal, consult the FAQ section on the www.fapceramiche.com.

Pour toutes les instructions de pose, de nettoyage et d'élimination, consultez le site www.fapceramiche.com à la section FAQ.

Für alle Anweisungen für das Verlegen, Reinigen und Entsorgen besuchen Sie bitte die Website www.fapceramiche.com im Bereich FAQ.

Puede consultar todas las instrucciones de colocación, limpieza y eliminación en la sección de preguntas frecuentes (FAQ) del sitio web www.fapceramiche.com.

Для любой информации по укладке, очистке и утилизации посетите страницу Частых Вопросов на сайте www.fapceramiche.com.

I colori e le caratteristiche estetiche dei materiali illustrati nel presente catalogo sono da ritenersi puramente indicativi.

Colours and optical features of the materials illustrated in this catalogue are to be regarded as mere indications.

Die Farben und die ästhetischen Eigenschaften der in diesem Katalog abgebildeten Produkte sind als reine Richtwerte zu betrachten.

Les coloris et les caractéristiques esthétiques des références illustrées dans le catalogue sont donnés à titre purement indicatif.

Los colores y las características ópticas de los materiales ilustrados en este catálogo deben ser mirados como indicaciones meras.

Цвета и эстетические характеристики описанных в настоящем каталоге материалов являются только ориентировочными.

Fap ceramiche si riserva di apportare modifiche e/o eliminare senza preavviso i prodotti declinando ogni responsabilità per danni diretti o indiretti derivanti da eventuali modifiche.

Fap ceramiche can change the indicated products without notice declining any responsibility for direct or indirect damage that depend on these changes.

Fap ceramiche se réserve le droit de modifier sans préavis les produits indiqués et décline toute responsabilité pour dommages directs ou indirects dus à éventuelles modifications.

Fap Ceramiche se reserva la facultad de modificar los productos sin preaviso, declinando cualquier responsabilidad por daños directos o indirectos que dependan de estos cambios.

Fap ceramiche kann die genannten Produkten ändern ohne Voranmeldung und lehnt dabei jegliche Verantwortung für die davon abhängenden direkten oder indirekten Schäden ab.

Компания "Fap ceramiche" сохраняет за собой право на внесение изменений в продукцию без предварительного уведомления, снимая с себя всякую ответственность за связанный с этими изменениями прямой или косвенный ущерб.

Fap ceramiche - 3rd edition (web) January 2022 - 1st edition September 2015

È vietata la riproduzione anche parziale dell'opera in tutte le sue forme.

Reproduction of this printed catalogue, even partially, is prohibited.





**MOSCOW
SHOWROOM**

Via Ghiarola Nuova, 44 - 41042 Fiorano Modenese (MO) Italy
tel. +39 0536 837511 - fax +39 0536 837532 - fax estero +39 0536 837542
www.fapceramiche.com - info@fapceramiche.com



Khamovnichevskiy Val, 36 - Moscow Metro / Sportivnaya tel. +7 (495) 775 05 20
www.fapceramiche.ru - moscow@fapceramiche.com