

BASALTINA STONE PROJECT





**Quella dura
potenza, intrinseca
alla pietra.**

**La forza della terra si cristallizza
in una pietra lavica.**

**La basaltina, fatta di calore,
ceneri, gas, energie millenarie.
Il suo grigio naturale rivive oggi
nella ceramica, acquistando toni
e sfumature nuove. Riempie gli
spazi con gusto e discrezione; ogni
venatura trattiene una storia.**

**The hard,
intrinsic power
of stone.**

**The power of earth crystallizes
in lava stone.**

**Basalt rock, made of heat,
ashes, gas and energies
thousands of years old. Its
natural grey comes back to
life again in ceramics, taking
on new tones and variations. It
fills spaces with subtle style, as
every vein holds a story within.**

LAPPATA

STUCCATA

NATURALE

SABBIATA

SABBIATA VELVET

TEXTURE

SCALPELLATA

**BASALTINA
STONE
PROJECT**

7 COLORI

7 COLORS

lappata
stuccata
naturale
sabbata
sabbata velvet
texture
scalpellata

**3 FORMATI
DISPONIBILI**

3 SIZES
AVAILABLE

60x120 cm
24"x48"
60x60 cm
24"x24"
30x60 cm
12"x24"

LAPPATA 30x60cm - 12"x24"
MOSAICO 1 LAPPATA 28,5x28,5cm - 11¹/₄"x11¹/₄"



BATHROOM

LAPPATA 30x60cm - 12"x24"



MOSAICO 1 LAPPATA 28,5x28,5cm - 11 1/4"x11 1/4"



NATURALE 30x60cm - 12"x24"
SABBIATA 60x60cm - 24"x24"

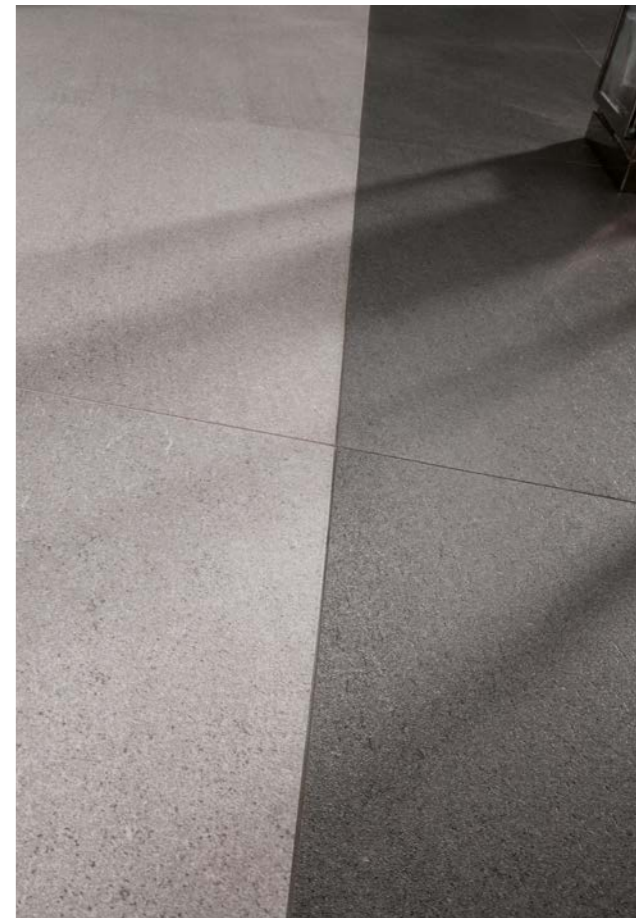

OUTDOOR



RESIDENTIAL AREAS

STUCCATA 60x60cm - 24"x24"





PUBLIC AREAS

SCALPELLATA 30x60cm - 24"x24"



SCALPELLATA

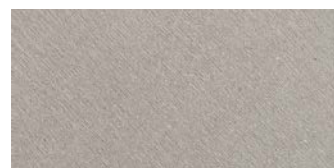

30x60cm / 12"x24"
rett. (spessore 11mm)

LGVBSR6



60x60cm / 24"x24"
rett. (spessore 11mm)

LGWBSR6

SABBIATA

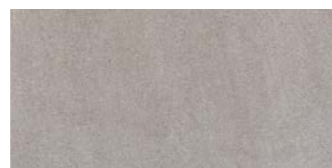

30x60cm / 12"x24"
rett. (spessore 11mm)

LGVBSR0



60x60cm / 24"x24"
rett. (spessore 11mm)

LGWBSR0



60x120cm / 24"x48"
rett. (spessore 12mm)

LGXBSRA

SABBIATA VELVET



30x60cm / 12"x24"
rett. (spessore 11mm)

LGVBSRE



60x60cm / 24"x24"
rett. (spessore 11mm)

LGWBSRE



60x120cm / 24"x48"
rett. (spessore 12mm)

LGXBSRE

TEXTURE



30x60cm / 12"x24"
nat. rett. (spessore 11mm)
lev. rett. (spessore 11mm)

LGVBSR7
LGWBSL7

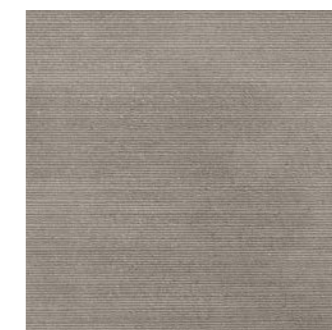

60x60cm / 24"x24"
nat. rett. (spessore 11mm)
lev. rett. (spessore 11mm)

LGWBSR7
LGWBSL7

NATURALE



30x60cm / 12"x24"
rett. (spessore 11mm)

LGVBSR1



60x60cm / 24"x24"
rett. (spessore 11mm)

LGWBSR1



60x120cm / 24"x48"
rett. (spessore 12mm)

LGXBSRB

STUCCATA

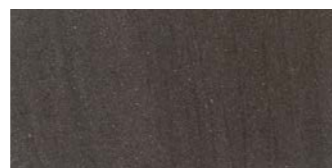

30x60cm / 12"x24"
rett. (spessore 11mm)

LGVBSR2



60x60cm / 24"x24"
rett. (spessore 11mm)

LGWBSR2



60x120cm / 24"x48"
rett. (spessore 12mm)

LGXBSRC

LAPPATA

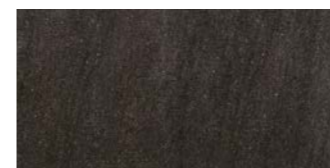

30x60cm / 12"x24"
rett. (spessore 11mm)

LGVBSL3



60x60cm / 24"x24"
rett. (spessore 11mm)

LGWBSL3



60x120cm / 24"x48"
rett. (spessore 12mm)

LGXBSRD

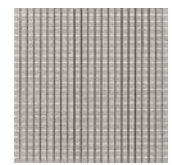

MOSAICO 1
sabbiata
28,5x28,5cm / 11¹/₄"x11¹/₄"
LG9BS00



MURETTO
sabbiata
30x60cm / 12"x24"
LG9BS05

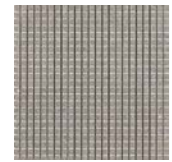

MOSAICO 1
sabbiata velvet
28,5x28,5cm / 11¹/₄"x11¹/₄"
LG9BS19



MURETTO
sabbiata velvet
30x60cm / 12"x24"
LG9BS49

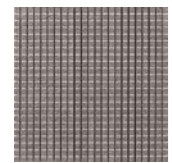

MOSAICO 1
naturale
28,5x28,5cm / 11¹/₄"x11¹/₄"
LG9BS01



MURETTO
naturale
30x60cm / 12"x24"
LG9BS06

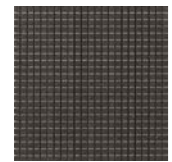

MOSAICO 1
stuccata
28,5x28,5cm / 11¹/₄"x11¹/₄"
LG9BS02



MURETTO
stuccata
30x60cm / 12"x24"
LG9BS07

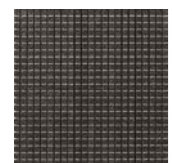

MOSAICO 1
lappata
28,5x28,5cm / 11¹/₄"x11¹/₄"
LG9BS03



MURETTO
lappata
30x60cm / 12"x24"
LG9BS08

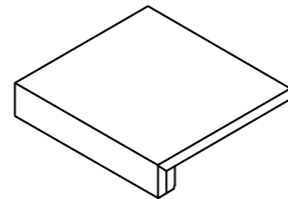

ANGOLO SX GRADINO PLUS*
35x35cm / 13³/₄"x13³/₄"
texture nat. LG9BSZ7
texture lev. LG9BSZ8
scalpellata LG9BSZ6

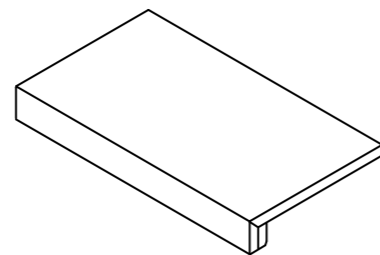

GRADINO PLUS*
35x60cm / 13³/₄"x24"
texture nat. LG9BSX7
texture lev. LG9BSX8
scalpellata LG9BSX6

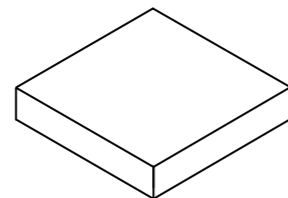

ANGOLO DX GRADINO PLUS*
35x35cm / 13³/₄"x13³/₄"
texture nat. LG9BSY7
texture lev. LG9BSY8
scalpellata LG9BSY6

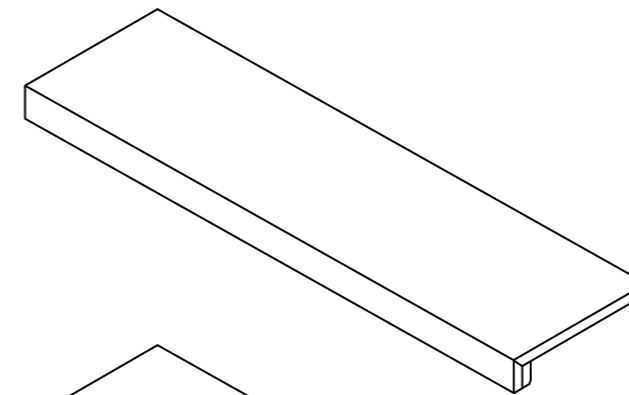

ANGOLO SX GRADINO PLUS*
35x120cm / 13³/₄"x48"
sabbiata LG9BS00
sabbiata velvet LG9BS07
naturale LG9BS01
stuccata LG9BS02
lappata LG9BS03

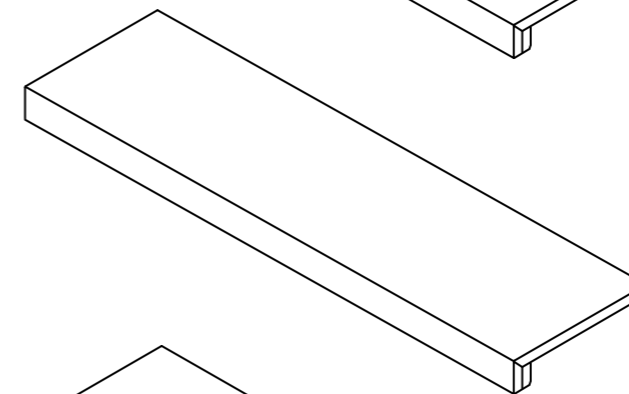

GRADINO PLUS*
35x120cm / 13³/₄"x48"
sabbiata LG9BSP0
sabbiata velvet LG9BSP6
naturale LG9BSP1
stuccata LG9BSP2
lappata LG9BSP3

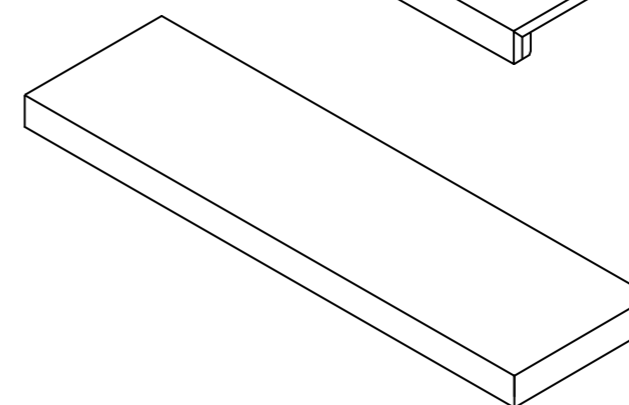

ANGOLO DX GRADINO PLUS*
35x120cm / 13³/₄"x48"
sabbiata LG9BSD0
sabbiata velvet LG9BSD7
naturale LG9BSD1
stuccata LG9BSD2
lappata LG9BSD3

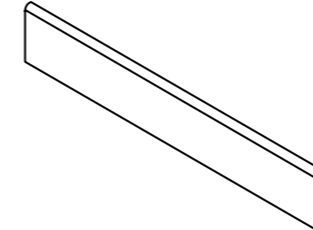

BATTISCOPA
10x60cm / 4"x24"
sabbiata LG9BSR0
sabbiata velvet LG9BSRE
naturale LG9BSR1
stuccata LG9BSR2
scalpellata LG9BSR6
texture nat. LG9BSR7
lappata LG9BSR3
texture lev. LG9BSL7

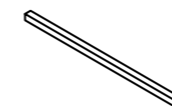

RACCORDO JOLLY
1,3x30cm / 1/2"x12"
sabbiata LG9BS31
sabbiata velvet LG9BS31
naturale LG9BS32
stuccata LG9BS33
lappata LG9BS34
scalpellata LG9BS36
texture lev. LG9BS37
texture nat. LG9BS38



BEAK JOLLY
1,3x1,3cm / 1/2"x1/2"
sabbiata LG9BS40
sabbiata velvet LG9BS40
naturale LG9BS41
stuccata LG9BS42
lappata LG9BS43
scalpellata LG9BS45
texture lev. LG9BS47
texture nat. LG9BS48

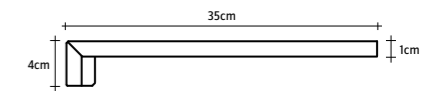

















BASALTINA STONE PROJECT

gres tutta massa UGL









full-body porcelain
grès cérame en pleine masse
vollgemischtes durchgefärbtes feisteinzeug

spessore 11mm / 12mm

thickness
épaisseur
stärke

caratteristiche tecniche* technical characteristics caractéristiques techniques technische eigenschaften	metodo di prova test method methode d'essai prüfmethode	fondi plain tile fond unifliese
 assorbimento d'acqua (E) water absorption (E) absorption d'eau (E) wasserabsorption (E)	iso 10545-3	≤ 0,04%
 resistenza al gelo frost resistance résistance au gel frostbeständigkeit	iso 10545-12	resistente résistant beständig
 resistenza alla flessione bending strength résistance à la flexion beigefestigkeit	iso 10545-4	≥ 50 N/mm ²
 sforzo di rottura (S) breaking strength (S) chargement de rupture (S) bruchlast (S)	iso 10545-4	≥ 3000 N
 resistenza all'abrasione profonda résistance to deep abrasion résistance à l'abrasion profonde widerstand gegen tiefenabrieb	iso 10545-6	≤ 145 mm ³
 dilatazione termica lineare thermal expansion dilatation thermique linéaire thermische dilatation	iso 10545-8	$\alpha \leq 7 \times 10^{-6} \text{ } ^\circ\text{C}^{-1}$
 resistenza agli sbalzi termici thermal shock resistance résistance aux chocs thermiques temperatur wechselbeständigkeit	iso 10545-9	resistente résistant beständig
 resistenza attacco chimico chemical resistance résistance chimique chemischee beständigkeit	iso 10545-13	uha, ula resistente résistant beständig
 resistenza alle macchie stain resistance résistance aux taches fleckenbeständigkeit	iso 10545-14	5 resistente résistant beständig
 resistenza allo scivolamento slip resistance résistance au glissement rutschfestigkeit	din 51130	R10 (naturale/stuccata/ texture naturale/sabbiata velvet) R11 (sabbiata/scalpellata)
 resistenza allo scivolamento slip resistance résistance au glissement rutschfestigkeit	din 51097	A+B+C (sabbiata/scalpellata)
 coefficiente di attrito dinamico dynamic friction coefficient coefficient de friction dynamique dynamischer reibungskoeffizient	B.C.R. tortus	$\mu > 0,40$ (sabbiata/sabbiata velvet/ scalpellata/naturale/stuccata/ texture naturale)
 coefficient of friction	astm c1028	wet/dry COF ≥ 0.60 (sabbiata/ sabbiata velvet/scalpellata/ naturale/stuccata/ texture naturale)
 dynamic coefficient of friction (DCOF)	ANSI A 137.1:2012 (BOT 3000)	DCOF ≥ 0.42 (naturale/stuccata/ sabbiata velvet) DCOF ≥ 0.62 (sabbiata/scalpellata)
 wet pendulum test AUS	AS 4586:2013	class W (sabbiata/scalpellata)
 pendulum test UK	BS 7976:2002	slider 96 wet: 36+ (sabbiata/ scalpellata) slider 55 wet: 36+ (sabbiata/ scalpellata)
 stonalizzazione shading denuançage spielfarbig		V3

*ISO 13006-G Bla UGL – EN 14411-G Bla UGL – ANSI A 137.1 (Un glazed Porcelain Tiles - Class P1)

impieghi uses emploi anwendungsbereiche		
 alberghi hotels hotels hotels		locali pubblici public spaces lieux publics öffentliche bereiche
 abitazioni housing maisons wohnbereiche		aeroporti airports aéroports flughafen
 bar - ristoranti bar - restaurants bar - restaurants cafés - restaurants, gasthäuser		centri commerciali malls centre commerciaux einkaufszentren
 negozi shops magasins geschäfte		stazioni train stations gares bahnhöfe

imballaggi packing emballage verpackungen

articolo	scatola		europallet					
	cm	inch	pz.	mq	kg	scat.	mq	kg
fondo	60x120	24"x48"	2	1,44	40,8	24	34,6	979,2
fondo	60x60	24"x24"	4	1,44	35,0	24	34,6	840,0
fondo	30x60	12"x24"	8	1,44	34,9	32	46,1	1116,8
mosaico 1	28,5x28,5	11 1/4"x11 1/4"	5	0,41	7,8	48	19,5	372,0
muretto	30x60	12"x24"	4	0,72	15,2	30	21,6	456,0
battiscopa	10x60	4"x24"	12	7,2 m.l.	18,0	55	396,0 m.l.	990,0
gradino plus	35x120	13 3/4"x48"	2	0,84	25,2	24	20,2	604,8
angolo gradino plus	35x120	13 3/4"x48"	1	0,42	13,5	24	10,1	324,0
gradino plus	35x60	13 3/4"x24"	4	0,84	23,2	16	13,4	371,2
angolo gradino plus	35x35	13 3/4"x13 3/4"	4	0,49	14,8	30	14,7	444,0
raccordo jolly	1,3x30	1/2"x12"	8	0,03	0,3	-	-	-
beak	1,3x1,3	1/2"x1/2"	4	-	-	-	-	-

Le rappresentazioni fotografiche e descrittive dei prodotti di Lea Ceramiche riportate sui depliant, sui cataloghi e sugli altri materiali pubblicitari dell'azienda, sono puramente illustrative dello specifico prodotto rappresentato. Si precisa infatti che, successivamente alla pubblicazione dei materiali pubblicitari dell'azienda, il prodotto potrebbe subire leggere modifiche nel relativo processo produttivo, al fine di renderlo tecnologicamente migliore. Tali aggiustamenti tecnologici potrebbero determinare lievi differenze, anche estetiche e/o cromatiche, nel prodotto medesimo, con la conseguenza che lo stesso potrebbe risultare diverso da come rappresentato e/o illustrato e/o descritto nel materiale pubblicitario di Lea Ceramiche. Tali differenze non potranno essere in alcun modo considerate dall'acquirente un vizio e/o difetto del materiale ceramico stesso, bensì una caratteristica dello specifico prodotto. Tutti i materiali ceramici che imitano pietre naturali presentano differenze di colore e sfumature che non potranno in nessun modo essere considerate quale difetto del prodotto, ma bensì una qualità caratteristica di tali tipi di produzione.

The photographs and descriptions of Lea Ceramiche products given in the brochures, catalogues and other corporate advertising materials aim merely to represent the specific products. After the publication of the corporate advertising materials, the products may be slightly modified as a result of technological improvements. Such technological modifications may lead to slight differences in appearance and/or colour of the products, which may therefore differ from the representations, illustrations or descriptions given in the Lea Ceramiche advertising materials. Such differences shall in no way be deemed to be faults and/or defects in the ceramic materials, but rather intrinsic features of the specific products. All ceramic materials that imitate natural stone differ in color and nuances, and this cannot any in way be considered as a product defect, but rather a characteristic of these types of products.



iso 14001



iso 9001



emas

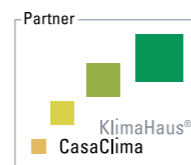

casaclima ***



leed*

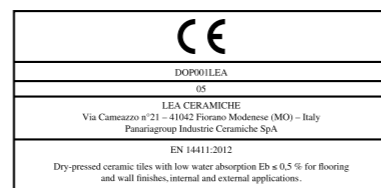

marchio CE



leed**



ecolabel

*** CASACLIMA
Lea Ceramiche, tramite la holding Panariagroup Industrie Ceramiche S.p.A., ha ottenuto la certificazione Partner Casaclima.
Through Panariagroup Industrie Ceramiche S.p.A., Lea Ceramiche has obtained the Partner Casaclima certification.
Par le biais de Panariagroup Industrie Ceramiche S.p.A., Lea Ceramiche a obtenu la certification Partner Casaclima.
Lea Ceramiche, durch die Holding Panariagroup Industrie Ceramiche S.p.A., hat die Bescheinigung als Partner Casaclima bekommen.
Lea Ceramiche, a través del holding Panariagroup Industrie Ceramiche S.p.A., ha obtenido la certificación Partner Casaclima.

* LEED
Lea Ceramiche, tramite la holding Panariagroup Industrie Ceramiche S.p.A., è socio ordinario del Green Building Council e del GBC Italia.
Through Panariagroup Industrie Ceramiche S.p.A., Lea Ceramiche is an ordinary member of the Green Building Council and the GBC Italia.
Par le biais de Panariagroup Industrie Ceramiche S.p.A., Lea Ceramiche est membre ordinaire du Green Building Council et du GBC Italia.
Lea Ceramiche, durch die Holding Panariagroup Industrie Ceramiche S.p.A., ist ordentliches Mitglied von dem Green Building Council und dem GBC Italien.
Lea Ceramiche, a través del holding Panariagroup Industrie Ceramiche S.p.A., es miembro afiliado del Consejo Construcción Verde y del Consejo Construcción Verde de Italia.

** LEED
Il contenuto di materiale riciclato "pre-consumo" della serie Basaltina Stone Project è del 40%, come certificato da ente esterno qualificato (certificato disponibile sul sito www.ceramichelea.com).
Basaltina Stone Project is produced with 40% of pre-consumer materials, as certified by a qualified external company (certificate available on the website www.ceramichelea.com).



ADI MEMBER

BASALTINA STONE PROJECT

LEA
CERAMICHE

LEA CERAMICHE
Via Cameazzo, 21
41042 Fiorano Modenese
Modena Italy

Tel +39 0536 837811
Fax +39 0536 830326
info@ceramichelea.it
www.ceramichelea.com

Panariagroup Industrie Ceramiche
S.p.A.

SHOWROOM LEA CERAMICHE
Via Durini, 3
20122 Milano

Tel +39 02 76011406
showroom_milano@ceramichelea.it

LEA NORTH AMERICA, LLC
800 Clanton Road, Suite N
Charlotte, NC 28217

Tel +1 704 522 6300
Fax +1 704 522 6080
info@leausa.us
www.leausa.us

